



City of Rancho Cordova Americans with Disabilities Act Transition Plan



May 5, 2005

Prepared for:
Rancho Cordova Public Works Department

Prepared by:
Moore Iacofano Goltsman (MIG)

Acknowledgements

City of Rancho Cordova City Council

Linda Budge Mayor
Dan Skoglund Council Member
Ken Cooley Mayor Pro Tem
Robert McGarvey Council Member
David Sander Council Member

City of Rancho Cordova

Ted A. Gaebler City Manager
Cyrus Abhar City Engineer
Kathy Garcia Project Engineer

Submitted by:

Moore Iacofano Goltsman (MIG)

in association with:

Dowling Associates, Inc.
Logan Hopper Associates
All Traffic Data
The Hoyt Company
Sprinkle Consulting, Inc.
Toole Design Group

Table of Contents

Section 1: Executive Summary..... 1

Section 2: Introduction and Administrative Information.....6

Section 3: Public Participation and Input 12

Section 4: Inventory Methodology and Findings.....26

Section 5: ADA Codes and Standards44

Section 6: ADA Capital Implementation Plan.....67

Section 7: Monitoring and Status Reporting.....82

Appendix A: Glossary94

Appendix B: Standard City Improvement Drawings.....96

Appendix C: Capital Implementation Program Project List..... 124

List of Tables

Table 1: Pedestrian Constraints (or Difficulties) Reported..... 17

Table 2: Walking Constraint Consumer Survey Responses18

Table 3: Summary of ADA Implementation Plan Projects by Fiscal Year80

List of Figures

Figure 1: Walkway Examples.....27

Figure 2: Curb Ramp Needs Example - Winn Elementary School on Vanguard Dr and Jupiter Dr31

Figure 3: Utility Pole Obstruction Examples - Mather Field Road at the Mather Sports Complex and Senior Center
..... 31

Figure 4: Bus Stop Path-of-Travel Example - Folsom Blvd and Routier Rd 32

Figure 5: Barrier for Vertical Clearance Less than 80 Inches.....51

Figure 6: Curb Ramp Components53

Figure 7: Perpendicular Curb Ramp54

Figure 8: Parallel Curb Ramp55

Figure 9: ADA Projects by Fiscal Year81

Section 1: Executive Summary

Introduction

The main purpose of the Americans with Disabilities Act (ADA) Transition Plan and Pedestrian Master Plan project is to develop policies and practices for implementing physical pedestrian improvements within the public right-of-way of the City of Rancho Cordova. The goal is to optimize the pedestrian experience, to provide safe and usable pedestrian facilities for all pedestrians, and to assure compliance with all federal, state and local regulations and standards.

This report originally was initiated for Sacramento County's ADA Transition Plan and Pedestrian Master Plan when Rancho Cordova was part of the unincorporated County. Dowling Associates staff extracted the relevant data from the original version as part of the Rancho Cordova Pedestrian and ADA Transition Plan Data Extraction project. Thus, information on the Sacramento County efforts is provided herein yet only when it pertains to Rancho Cordova.

The ADA Transition Plan and the Pedestrian Master Plan were on a parallel schedule, but had separate adoption processes. The ADA Transition Plan is intended to represent both the legal and functional goals and objectives of the City to make the existing pedestrian facilities within the City right-of-way accessible and usable for persons with disabilities. The City of Rancho Cordova developed the Pedestrian Master Plan to enhance walking as a viable transportation choice to help make Rancho Cordova a better place to live. The Pedestrian Design Guidelines, as part of the Pedestrian Master Plan, addresses new design standards to make facilities better for all pedestrians.

The ADA requires all public agencies to develop an ADA Transition Plan for the installation of curb ramps or other sloped areas at all locations where walkways cross curbs. The plan must include a schedule for curb ramp installation and for other improvements necessary to achieve programmatic accessibility for persons with disabilities. The main purpose of this ADA Transition Plan is to describe the curb ramp and other pedestrian facility needs in the City, and to outline the recommended procedures for implementing and scheduling remedial work to provide a complying system of curb ramps, pedestrian signals and sidewalks.

The ADA Transition Plan and the Pedestrian Master Plan cover the City of Rancho Cordova in its entirety. The City has a wide variety of facilities within the public right-of-way. These facilities include streets and roadways, vehicular and pedestrian bridges, underground and above-ground utilities, vehicular and pedestrian signal systems, signage systems, on-street parking facilities, walkways, sidewalks with curb ramps at intersections, planting strips and buffers, pedestrian activity areas and unimproved open spaces.

Public Participation

Rancho Cordova residents were able to take advantage of the following outreach efforts:

- **Advisory Groups:** Two advisory committees, the ADA Community Advisory Group (CAG) and the Technical Advisory Committee (TAC) were formed and met regularly over a period of one and a half years to review documents and to provide feedback. Both groups contained members of the local disability community.
- **Outreach to Persons with Visual Impairments:** The ADA Transition Plan will be made available to persons who are visually impaired via large print text document and Braille master copy. Persons with visual impairments who have access to software that converts text to audio will be provided the document via e-mail, floppy disks or CDs. The California Access News has a free telephone reader service for individuals who are blind or with visual impairments that includes information on the ADA Transition Plan.
- **Community Planning Advisory Councils (CPAC):** The study team presented the scope of work for the project to the interested CPACs in the unincorporated Sacramento County, which included the Cordova CPAC (CORPAC) on September 12, 2002. Attendees of the CPAC meetings were given an opportunity for input into the process.
- **Consumer Survey:** The study team developed and distributed a pedestrian and disabled access consumer survey to identify hotspot locations or physical barriers to walking.
- **Press Releases:** The study team created and distributed press releases to cover the following topics: project kick-off, consumer surveys, transportation fairs and the draft ADA Transition Plan.
- **Transportation Fairs:** The study team described the project's activities in hands-on settings at four separate venues throughout the unincorporated County.
- **Web Site:** City of Rancho Cordova project web site was created to disseminate information about the project.
- **Electronic Newsletter:** Electronic newsletters and announcements were distributed to the public via the project listserv.
- **Focus Group Presentations:** The City of Rancho Cordova met with the following organizations to discuss the draft ADA Transition Plan: the National Federation of the Blind, California Council of the Blind, California for Disability Rights and CORPAC.
- **Public Workshop and Hearing:** The City Council held a public workshop on the draft ADA Transition Plan, which began a 45-day comment period on the draft document. The City Council then held a public hearing to approve the ADA Transition Plan. Rancho Cordova residents were able to submit formal comments about this ADA Transition Plan, either in written form or at a public workshop. The City of Rancho Cordova was in charge of the public workshop and hearing.

Inventory Efforts

This inventory effort was initiated as part of the Sacramento County's ADA Transition Plan and Pedestrian Master Plan effort when Rancho Cordova was part of the unincorporated

County. Dowling Associates staff extracted the relevant inventory data from the original version as part of the Rancho Cordova Pedestrian and ADA Transition Plan Data Extraction project.

The study team conducted a five-month survey of pedestrian facilities to document existing conditions within the public rights-of-way. These data were used to recommend improvements to pedestrian facilities and to comply with ADA and State Title 24 requirements. Surveying refers to visiting the particular location by a trained accessibility surveyor, and obtaining measurements, dimensions, gradients or other visual determinations as may be appropriate depending on the particular location.

Highlights of the survey process and inventory findings pertinent to the City are listed below:

- Approximately 72 miles of streets and roadways covering over 578 individual segments of roadway boundaries were traveled and surveyed to document physical conditions along the roadways, including conditions that might be barriers to persons with disabilities.
- The inventory focused on more heavily used roadways and intersections and on those roadways and intersections serving governmental, public service and commercial uses.
- For roadways surveyed, approximately 85 percent of City roadways have sidewalks on one or both sides, and 15 percent do not have sidewalks on either side of the street.
- Approximately 718 intersections or 1,685 street corners were surveyed, and measurements were taken for a variety of dimensions and gradients.
- Approximately 73 percent of all corners surveyed have rolled curbs, approximately 19 percent have vertical curbs, and 7 percent do not have curbs.
- Approximately 27 percent of all developed corners have curb ramps. Of these, approximately 58 percent were older perpendicular curb ramps with flared sides and approximately 38 percent were newer parallel pan-type curb ramps.

All survey findings are contained in a Microsoft Access database titled the Sidewalk and Intersection Database. The database is designed to be user-friendly, with interactive screens available to access the summary report and reports for each individual intersection or roadway segment.

ADA Codes and Standards

ADA Codes and Standards were developed for all facilities within the public right-of-way. The standards are intended to apply to all construction undertaken within the public right-of way after the final approval of the ADA Transition Plan. The ADA CAG and the TAC reviewed three versions of the ADA Codes and Standards. The final draft document was submitted for review on April 25, 2003. This final draft version was reviewed at ADA CAG and TAC meetings on June 2, 2003.

The ADA Codes and Standards were developed to combine and resolve any conflicts between the *Americans with Disabilities Act Accessibility Guidelines* (ADAAG), published by the U.S. Architectural and Transportation Barriers Compliance Board in July 1991, and the *California State Building Code, Title 24, Part 2*, of the California Code of Regulation, 2001 edition. *Draft Guidelines for Public Rights-of-Way*, published by the U.S. Architectural and Transportation Barriers Compliance Board on June 17, 2002, which are expected to take effect in the future, also were considered in the ADA Codes and Standards. In addition, all approved policies and standards affecting accessibility in the public right-of-way were included in the standards. This report considered Sacramento County standards because it originally was prepared for Sacramento County's ADA Transition Plan and Pedestrian Master Plan when Rancho Cordova was part of the unincorporated County. These policies have been adopted by the City of Rancho Cordova.

ADA Capital Implementation Plan

The ADA Capital Implementation Plan describes the extent of City-operated and other participants' projects necessary to implement the ADA Transition Plan within the City public rights-of-way.

Types of projects included in the ADA Capital Implementation Plan can be categorized as follows:

- Curb ramp construction or replacement projects based upon resident requests.
- Curb ramp, sidewalk and intersection retrofit projects included with street overlay or other street or sidewalk construction projects.
- Curb ramp, sidewalk and intersection retrofit projects, in conjunction with construction by private parties.
- Curb ramp, sidewalk and intersection retrofit projects deemed essential for mitigation of barriers based upon the finalized ADA Transition Plan.
- Street and sidewalk construction or retrofit projects planned for the improvement of overall pedestrian facilities.
- Signal retrofit projects.
- Roadway widening projects.

A number of existing and potential programs and funding sources for capital improvement projects were evaluated. These programs include on-going capital improvement and maintenance programs as well as specific projects and funding sources allocated in the City's five year Transportation Improvement Plan (TIP). The ADA Capital Implementation Plan uses, to the maximum extent possible, existing and prospective funding programs and sources. The plan recommends specific goals for the construction of accessibility improvements. While specifying locations and the scope of work required at these locations, the plan also is intended to serve as a conceptual plan whereby the extent of future projects can be evaluated prior to preparing detailed cost estimates. Once an overall scope of work and its financial impact is established, annual projects can be finalized and the exact number of specified improvements can be set as project goals.

Curb ramps should be installed at all locations where they are missing and necessary for the full usage of the overall pedestrian path of travel, including at mid-block crosswalks. Older non-conforming curb ramps that pose potential hazards to wheelchair users should be repaired, upgraded or replaced. Some of these curb ramps may be ineffective or even dangerous due to steep slopes, narrow widths, high gutter lips and offset locations that require users to enter and exit streets outside of crosswalks. In addition to curb ramp construction and replacement, crosswalks, pedestrian signals and sidewalks serving each selected intersection should be evaluated for compliance with the ADA Codes and Standards and upgraded where necessary.

The ADA Capital Implementation Plan includes a detailed and prioritized list of approximately 246 project locations and items of work, which have been reviewed by the City, the ADA CAG and the TAC. This implementation plan, which targets higher priority uses, anticipates a 15- to 20-year implementation period to achieve compliance with program accessibility requirements. Additional ADA work, such as new construction and additional curb ramps beyond the minimum program access requirements, will continue beyond the timeframe identified above.

Monitoring and Status Reporting

The City currently is engaged in an on-going effort to construct curb ramps, sidewalks and other facilities at numerous locations. This construction activity involves several types of projects, including street overlay projects, street beautification projects, utility construction projects and other capital improvement projects in the public right-of-way. In addition, when this ADA Transition Plan is approved and implemented, more curb ramps and related improvements will be constructed.

While it is important to assure that codes and standards used to design and construct curb ramps and related improvements are up-to-date, it is equally important that improvements are constructed properly and in compliance with all applicable codes and standards. Therefore, the monitoring of construction activities and the reporting of the status of improvements is vital in assuring an effective overall compliance program.

The ADA Transition Plan details the methods and procedures for monitoring these construction activities and for tracking the status of compliance with the plan at all construction locations within the City.

Section 2: Introduction and Administrative Information

Section 2.1: Introduction to the ADA

The Americans with Disabilities Act (ADA), enacted on July 26, 1990, provides comprehensive civil rights protections to persons with disabilities in the areas of employment, state and local government services, access to public accommodations, transportation and telecommunications. The ADA is companion civil rights legislation with the Civil Rights Act of 1964 and Section 504 of the Rehabilitation Act of 1973. This legislation mandates that qualified disabled individuals shall not be excluded from participation in, denied the benefit of, or be subjected to discrimination under any program or activity. The Act also protects employees with disabilities, with certain protections and requires employers to make reasonable accommodation for applicants and employees with disabilities.

The ADA is divided into five parts, covering the following areas:

Title I: Employment

Under Title I, employers, including governmental agencies, must ensure that their practices do not discriminate against persons with disabilities in the application, hiring, advancement, training, compensation or discharge of an employee, or in other terms, conditions and rights of employment.

Title II: Public Services

Title II prohibits state and local governments from discriminating against persons with disabilities or from excluding participation in or denying benefits of programs, services or activities to persons with disabilities. It is under this Title that this ADA Transition Plan has been prepared. The ADA Transition Plan is intended to outline the methods by which physical or structural changes will be made to affect the non-discrimination policies described in Title II.

Title III: Public Accommodations

Title III requires places of public accommodation to be accessible to and usable by persons with disabilities. The term public accommodation as used in the definition often is misinterpreted as applying to public agencies, but the intent of the term is to refer to any privately funded and operated facility serving the public.

Title IV: Telecommunications

Title IV covers regulations regarding private telephone companies, and requires common carriers offering telephone services to the public to increase the availability

of interstate and intrastate telecommunications relay services to individuals with hearing and speech impairments.

Title V: Miscellaneous Provisions

Title V contains several miscellaneous regulations, including construction standards and practices, provisions for attorney's fees and technical assistance provisions.

Title II of the ADA dictates that a public entity must evaluate its services, programs, policies and practices to determine whether they are in compliance with the nondiscrimination regulations of the ADA. The regulations detailing compliance requirements were issued in July 1991. A self-evaluation also is required. It is intended to examine activities and services, identify problems or barriers that may limit accessibility by persons with disabilities, and describe potential compliance solutions. The entity then must proceed to make the necessary changes resulting from the self-evaluation. The ADA further requires that an ADA transition plan be prepared to describe any structural or physical changes required to make programs accessible.

In the ADA, the term disability means, with respect to an individual:

- (1) A physical or mental impairment that substantially limits one or more of the major life activities of such individual;
- (2) A record of such an impairment; or
- (3) Being regarded as having such an impairment.

If an individual meets any one of these three tests, that person is considered to be an individual with a disability for purposes of coverage under the Americans with Disabilities Act. The Final Rules of the ADA describe in greater detail the conditions included and excluded as disabilities under the ADA. These rules are available upon request from the study team, and are incorporated by reference as part of this ADA Transition Plan.

Section 2.2: City of Rancho Cordova ADA Responsibilities

The City has various responsibilities under Title II of the ADA. Title II of the ADA is similar to Section 504 of the Rehabilitation Act of 1973, but differs in that Section 504 applies only to government agencies that receive federal financial assistance. The purpose of Section 504 is to ensure that no otherwise qualified individual with disabilities shall, solely by reason of disability, be discriminated against under any program or activity receiving federal financial assistance. The City has been subject to and operating under the requirements of Section 504 for many years.

The ADA states an intent not to apply lesser standards than are required under other federal, state or local laws; therefore, the law that is the most stringent has precedence. This intent has particular application with respect to the City's obligations under Section 504 or under Title 24 of the California Code of Regulations, which in some cases, exceed ADA requirements with respect to structural and physical changes.

Title II also mandates that City governments may not require eligibility criteria for participation in programs and activities that would screen persons with disabilities, unless it can be proven that such requirements are necessary for the mandatory provision of the service or program. A public entity must reasonably modify its policies and procedures to avoid discrimination toward disabled residents. Nevertheless, if the public entity can demonstrate that a modification fundamentally would alter the nature of its service, it would not be required to make that modification. Title II also discusses the use of auxiliary aids necessary to enable persons who have visual, hearing, mobility or similar impairments to gain access to programs and activities provided by the City so as to make an appropriate reasonable accommodation.

The lone exception to these requirements would be because of undue hardship. Undue hardship is defined in the ADA as an "action requiring significant difficulty or expense" when considering the nature and cost of the accommodation in relation to the size, resources and structure of the specific operation. Undue hardship is determined on a case-by-case basis.

A public entity also is required to designate a person to be responsible for coordinating the implementation of ADA requirements and for investigating complaints of alleged noncompliance. At the time of the ADA Transition Plan preparations, for the intent of this portion of the ADA Transition Plan that relates to streets, sidewalks and public rights-of-way, that designated person is Kathy Garcia, ADA Program Access Coordinator, City of Rancho Cordova, 3121 Gold Canal Drive, Rancho Cordova, CA 95670, Telephone (916) 942-0222, Fax: (916) 853-1691, e-mail: kgarcia@cityofranchocordova.org and TTY (916) 942-0226.

Section 2.3: ADA Transition Plan Requirements

According to ADA, a public agency is required to prepare an ADA Transition Plan if physical or structural modifications to facilities are required to provide access to programs or services. Title II of the ADA regulates government agencies, with its primary goal being to ensure that all of their programs and services are accessible to individuals with disabilities. The ADA Transition Plan is limited to evaluating physical barriers; however, an analysis of the programs and services rendered by the City also is important to determine what physical changes are necessary. The ADA Transition Plan documents what actions the City will take to alter its facilities. The ADA requires that the ADA Transition Plan be submitted for public review before final approval and adoption by the appropriate regulatory agency.

Generally, the ADA Transition Plan lists existing barriers in the public rights-of-way under the City's jurisdiction, and schedules which barriers to remove to provide access for individuals with disabilities to City programs. The City is required to provide access to all of its programs, but is not required to remove all architectural barriers in all of its facilities. In addition to making physical improvements, government agencies can choose among various administrative solutions, such as relocating or modifying a particular program, to obtain overall program access.

The ADA Transition Plan is required by Department of Justice rules to address the following aspects of accessibility:

- (1) If a public entity has responsibility or authority over streets, roads or walkways, its ADA Transition Plan shall include a schedule for providing curb ramps or other sloped areas where pedestrian walks cross curbs, giving priority to walkways serving entities covered by the ADA, including State and local government offices and facilities, transportation, places of public accommodation, and employers, followed by walkways serving other areas;
- (2) The ADA Transition Plan shall identify physical obstacles in the public entity's facilities that limit the accessibility of its programs or activities to individuals with disabilities;
- (3) The ADA Transition Plan shall describe the methods that will be used to make the facilities accessible; and
- (4) The ADA Transition Plan shall specify the schedule for taking the steps necessary to achieve compliance with the ADA and, if the time period of the ADA Transition Plan is longer than one year, identify steps that will be taken during each year of the transition period.

The ADA Transition Plan contains detailed physical barrier surveys of City streets, curb ramps and related facilities. These surveys are contained in a comprehensive computer database, and document barriers present at the time of the survey. The survey does not provide a complete listing of complying architectural or physical features. It also is important to note that improvements made to facilities after the date of the survey are not included as part of this ADA Transition Plan.

The ADA does not designate a specific code or standard for evaluating access to existing facilities. Title II gives government agencies a choice between the Uniform Federal Access Standards (UFAS) and the Americans with Disabilities Act Accessibility Guidelines (ADAAG) as a standard for renovations. Since the ADA states that it does not override requirements of other state and local requirements, the State of California Title 24 access regulations also must be applied. Therefore, for the purpose of this ADA Transition Plan, each facility or site area is evaluated based on the most stringent requirements of the 1991 ADA Accessibility Guidelines or 2001 Title 24.

In creating priorities, it is the City's intent to evaluate all areas of potential deficiency, and to make structural changes where necessary. The assignment of priorities is intended to facilitate public review and to address specific concerns of the local disabled community. It must be emphasized that it is the intent for all individuals with disabilities to be reasonably accommodated by the City.

Section 2.4: Description of Program Accessibility

The final Rules and Regulations of the ADA describe the requirements for program accessibility (Code of Federal Regulations, Title 28, Part 35, Subpart D). A public entity shall operate each service, program or activity, when viewed in its entirety, so that it is accessible to and usable by individuals with disabilities. The ADA does not require the public entity to make all of its existing facilities accessible, nor does it require a public entity to take any action that would fundamentally alter the nature of a service, program or activity. Also, it does not require implementation of the ADA that would result in undue financial and administrative burdens. In such cases where documentation is provided in keeping with strict procedures outlined in the ADA, there are various methods that may be appropriate for providing program accessibility in lieu of making actual physical changes to facilities.

With these facts in mind, the first step in determining what structural changes to existing facilities are necessary is to develop an understanding of the specific public programs and activities occurring at existing facilities within the City. This section attempts to describe the programs and activities in the public right-of-way. It should be noted that this section is not intended to be a self-evaluation, as described in the ADA. A self-evaluation includes an analysis of *all* programs and services offered by a public entity. The self evaluation may include communications, publications, employment and many other factors that are separate from proposed structural or physical modifications to facilities.

The activity of using the public right-of-way may be considered a program in two different ways:

- (1) Streets, sidewalks and curb ramps may be part of a continuous path of travel between activities or programs, at various public and private facilities located on adjacent properties, such as public offices, schools, parks and recreational facilities, public service agencies, hospitals and health clinics, police facilities and public housing uses.
- (2) Streets, sidewalks and curb ramps may themselves represent a program of public pedestrian activities that are essential to the usage and enjoyment of a city's built environment.

The Department of Justice's Title II Technical Assistance Manual points out that a public entity's programs related to streets, sidewalks and curb ramps may be prioritized with respect to relative importance and frequency of usage. It further describes that program accessibility would not require all streets, sidewalks and curb ramps to be fully accessible as required by current codes. A determination of what public rights-of-way are programmatically required to be accessible may vary from jurisdiction to jurisdiction.

Section 3: Public Participation and Input

Section 3.1 Introduction

The ADA states that a public entity is required to make available to applicants, participants, residents and other interested parties information regarding the ADA Transition Plan and its applicability to the services, programs or activities of the public entity, and to apprise the public of the protections against discrimination afforded to them by the ADA. A public entity also is required to provide an opportunity for interested persons, including individuals with disabilities or organizations representing individuals with disabilities, to participate in the development of the ADA Transition Plan by submitting comments and making specific recommendations. The ADA also requires that a copy of the draft ADA Transition Plan shall be made available for public inspection during a formal public review period.

The ADA Transition Plan project was set up to encourage and facilitate the maximum degree of participation from residents of the City of Rancho Cordova. This process included persons with disabilities and those representing disability service organizations. This section describes the public participation and outreach efforts made by the study team. The main objective of the outreach effort was to ensure that the ADA Transition Plan is one that truly represents the goals and aspirations of the local disability community.

Section 3.2: Community Participation

Introduction

The study team set up the ADA Transition Plan and Pedestrian Master Plan project to encourage and facilitate the maximum degree of public participation. This process included persons with disabilities and those representing disability service organizations. The outreach efforts included the following components as shown in bullet points and described in more detail below:

- Advisory Groups
- Outreach to Persons who are Visually Impaired
- Web Site
- Electronic Newsletter and List Serve
- Press Releases
- Transportation Fairs
- Community Planning Advisory Councils
- Consumer Survey (described in Section 3.3)
- Public Information Workshops (described in Section 3.4)

Rancho Cordova residents were able to submit formal comments about this ADA Transition Plan, either in written form or at a public workshop and a City Council hearing. The public workshop and City Council hearing were held in the City of Rancho Cordova.

Advisory Groups

As part of the ADA public participation process, advisory groups were formed to allow for additional input from key stakeholders, planning professionals, policy makers and the general public. The advisory groups acted as a sounding board for the ADA study team. Members reviewed and provided feedback on project documents and submittals. In addition, the advisory groups worked toward achieving consensus on project issues.

The following advisory groups were established:

- ADA Community Advisory Group (CAG) for the ADA Transition Plan;
- Technical Advisory Committee (TAC) for the ADA Transition Plan.

The ADA CAG and TAC members included representatives from the following organizations:

ADA Community Advisory Group (CAG)

- Agency For Hearing
- California Council for the Blind
- Californians for Disability Rights
- Folsom Cordova Unified School District
- Gray Panthers
- Human Rights/Fair Housing Commission
- National Federation of the Blind
- National Multiple Sclerosis Society
- Sacramento Riverfront Association
- Society for the Blind
- WalkSacramento

Technical Advisory Committee (TAC)

- Caltrans
- City of Sacramento Public Works Department
- Paratransit, Inc.
- Sacramento Area Council of Governments
- Sacramento County – Chief of the Disability Compliance Office
- Sacramento County – Construction Management
- Sacramento County – Department of Environmental Review and Assessment
- Sacramento County – Department of Parks and Recreation
- Sacramento County – Department of Water Resources

- Sacramento County – General Services
- Sacramento County – Planning Department
- Sacramento County – Sacramento Department of Transportation (SacDOT)
- Sacramento County - Sheriff's Department
- Sacramento Metropolitan Air Quality Management District
- Sacramento Municipal Utility District
- Sacramento Regional Transit District
- WalkSacramento

The study team met with the advisory committees at key milestones throughout the ADA Transition Plan. The first meeting for each group was in April 2002. Both groups held nine regular meetings, including draft ADA Transition Plan review meetings in January 2004. The CAG and the TAC also met concurrently at different stages to allow the joint groups to discuss key project components.

Outreach to Persons who are Visually Impaired

The ADA Transition Plan will be made available to persons who are visually impaired via large print text document and Braille master copy. Persons with visual impairments who have access to software that converts text to audio will be provided the document via e-mail, floppy disks or CDs. The Sidewalk and Intersection Database will be available for review by appointment at the ADA Program Access Coordinator's office at 3121 Gold Canal Drive, Rancho Cordova, CA.

California Access News' Local Content Section has a free telephone reader service for individuals who are blind or with visual impairments that includes information on the ADA Transition Plan. To access it, dial (916) 732-4000 and then 1 from the main menu. Interested parties may sign up as a subscriber by calling (916) 732-4010. The service was initiated for the ADA Transition Plan in August 2002, and received a total of 48 hits to the three project-related sites between August and December 2002. All information was updated on a regular basis to include upcoming events, meetings and documents.

Web Site

The ADA study team used the Sacramento County Department of Transportation web site as an additional means of disseminating information on the ADA Transition Plan as well as the Pedestrian Master Plan. The City of Rancho Cordova also has ADA-related information on their web site at: <http://www.cityofranhocordova.org/>

By using the web site, the public was able to obtain information on the project's purpose, schedule and timeline, pedestrian/ADA consumer survey, archived newsletters and related articles, approved and revised documents and discussion papers, public involvement opportunities and contact information. In addition, the draft and final ADA Transition Plan and Pedestrian Master Plan were posted on the City's web site for approximately 12 months after final approval and adoption.

Electronic Newsletter and Listserv

The study team used the e-mail list-serves and electronic newsletters to keep interested parties apprised of the project's progress. The study team found e-newsletters to be a cost-effective way of communicating to a broad audience. The e-newsletters also afforded the study team a convenient method of communicating project updates or upcoming public involvement opportunities on a frequent, real-time basis.

Newsletters also were made available in hard copy, large print, CD, floppy disk or electronic mail. The study team relied on the ADA and pedestrian-oriented organizations and other advocacy groups in the Sacramento area to distribute project information through their existing web sites and e-mail listservs.

Community Planning Advisory Councils

At the beginning of the project, the study team presented the ADA Transition Plan and Pedestrian Master Plan projects to the Community Planning Advisory Councils (CPACs) in Sacramento County including the Cordova CPAC (CORPAC) on September 12, 2002. The presentation focused on each plan's purpose, objectives, scope, schedule and community outreach and involvement opportunities. Attendees of the CPAC meetings were given an opportunity for input into the plan development process, as well as local problems such as safety issues, needed curb ramps and sidewalk connectivity. The study team distributed the consumer survey, as described in the next section, to CPAC meeting attendees to identify specific problem areas in their neighborhoods.

Section 3.3: Consumer Surveys

Introduction

The study team conducted a pedestrian and disabled access consumer survey to help identify specific community concerns, as well as hotspot locations or physical barriers to individuals with disabilities. The consumer survey also helped with the prioritization of the proposed projects as part of the ADA Capital Implementation Plan. The survey was designed to target all pedestrians, including individuals with disabilities.

The study team distributed questionnaires to public library branches throughout the County including Rancho Cordova and to individuals and organizations on the study team's mailing list. Paratransit, Inc. mailed out about 4,000 questionnaires along with a project newsletter to their consumers in the unincorporated County including Rancho Cordova when it was part of the unincorporated area. WalkSacramento also distributed the surveys to their members. The consumer survey was available on the project web site from September 2002 through April 2003.

For visually-impaired individuals, the questionnaire was made available in the following alternative formats:

- Audio tapes;
- Electronic using text files;
- Floppy disks;
- Large print documents;
- Telephone; and
- Telephone reader service (California Access News).

Survey Process

The goal was to receive at least 100 completed questionnaires from pedestrians who stated that they were disabled (all respondents were given the opportunity to decline stating that they had a disability) and at least 200 completed questionnaires from the general public. The study team collected and analyzed 197 questionnaires. Out of these surveys, 112 were filled out by individuals who stated that they had a disability.

The survey collected the following information:

- Disability type (optional);
- Reasons why respondent does not walk more;
- Purpose for walking (i.e., work, social/recreational, etc.);
- Time spent walking for each purpose; and
- Major walking constraints.

Survey Results

Statistically valid results were not necessarily drawn from the survey results, because the pedestrian respondents were not randomly selected. Nevertheless, these pedestrians did provide a broader picture of pedestrian activity in the unincorporated County. About 62 percent of the respondents were female, and the survey showed that the female respondents walk for a longer amount of time compared to the male respondents.

More respondents were older, and more respondents stated that they were disabled than the demographics of the unincorporated County. For example, 44 percent of the respondents were 60 years old or greater, and 57 percent of the respondents marked the optional question regarding disability. Furthermore, only 52 percent of the respondents owned a car or truck. According to the 1995 National Personal Transportation Survey (NPTS), one in ten households in the United States do not own an automobile. In interpreting these observations, it should be remembered that respondents, since they were self selected, are more likely to travel longer distances and for more purposes than the average resident in the unincorporated County.

Tables 1-2 illustrate the survey results as they pertain to Rancho Cordova. Table 1 shows that about ten percent of the survey respondents were from Rancho Cordova. Rancho Cordova respondents were more likely to be concerned about street crossing constraints than the other unincorporated areas and less about sidewalk constraints. Disabled accessibility constraints also were a more significant concern. Table 2 lists the actual comments made by the respondents when they gave specific intersection or roadway segment information.

Table 1: Pedestrian Constraints (or Difficulties) Reported

	Total Respondents	Sidewalk Constraints	Street Crossing Constraints	Disabled Accessibility Constraints
Rancho Cordova	50	10 20%	17 34%	14 28%
Unincorporated County (w/ Rancho Cordova)	494	170 34%	155 31%	86 17%

Table 2: Walking Constraint Consumer Survey Responses

Street Name	Cross Streets	Side walk	Tra XING	Disa nsit	bled	Lght	Comments
Coloma Rd	Sunrise				1		
Coloma Road	Truckee River		1				Traffic is going too fast to risk family and friends.
Coloma Road	Vehicle Drive		1	1	1	1	Transit riders run across Coloma Rd after disembarking buses.
Folsom	Aramon	1	1		1		
Folsom	Bradshaw		1				Wide street, short crossing time.
Folsom Blvd.	Cordova Lane	1	1		1		
Folsom Blvd.	Cordova Ln. and Olson Dr.	1					It is difficult for a rider to transition between the road and the sidewalk along the north side because of the height between the gutter and the road.
Folsom	Mills Park	1	1		1	1	
La Riviera	Folsom	1			1		Rough, wheel topples and chair almost tips
Mills Park	Mills Tower	1	1	1		1	Dirty, rocky road pathway to crossing - 1 hour schedule on bus there.
Mills Station Rd.				1	1		Unable to cross streets due to traffic. I use a walker, wheelchair and a cane.
Olson Drive	Olson, Zinfandel, Folsom		1	1	1		No crosswalks exist along Olson Drive except at the crossings. High-density retail and office buildings are separated by Olson Drive. Workers in the office traverse Olson without marked crossings.
Progress Court	Progress Court & Olson Dr		1	1			Heavily used public facility and post office in addition to church with any pedestrian crossings.
Progress Court			1				Progress Court and the location of the 95670 post office is also difficult.
Sunrise	Trinity River	1	1				Sunrise is basically a freeway that needs to be more pedestrian friendly.
Total	15	7	11	5	8	3	
Percent		47%	73%	33%	53%	20%	

Section 3.4: ADA Transition Plan Public Review and Comment Period

A public entity that employs 50 or more people is required to seek public input on its ADA Transition Plan. Beyond the legal requirements, public input is vital to assure that those affected by the City's programs, services and facilities understand the scope and nature of the City's responsibilities for providing equal access to the public. As described in the previous section, the ADA Transition Plan process has spanned several years, and considerable efforts to obtain public input have been undertaken during this period.

The study team held a City Council workshop on the draft ADA Transition Plan to begin the 45-day public review comment period. During this time, the study team presented the draft ADA Transition Plan at a public workshop that specializes in disabled access issues. A City Council Hearing on the final draft ADA Transition Plan was held to approve the plan. These meetings took place in early 2005.

The City of Rancho Cordova lead the public meetings, and contacted the key stakeholders including:

- Alta Regional
- Area 4 Agency on Aging
- California Council for the Blind
- California for Disability Rights
- McGregor Commons
- National Federation of the Blind
- Paratransit, Inc.
- Participants in Progress
- Regional Transit
- Sunrise Macular Degeneration Association
- Walk Sacramento

The draft ADA Transition Plan was available in alternate formats, and written comments were received in any alternative formats chosen by respondents. No public comments were received.

Requests for copies of the ADA Transition Plan and public comments should be directed to City of Rancho Cordova, Kathy Garcia, ADA Program Access Coordinator, 3121 Gold Canal Drive, Rancho Cordova, CA, 95670, Telephone: (916) 942-0222, Fax (916) 853-1691, e-mail: kgarcia@cityofranchocordova.org, TTY (916) 942-0226. The ADA Transition Plan is provided in various alternative formats upon written request.

Section 3.5: ADA Grievance Procedures

Introduction

The ADA states that a public entity is required to apprise the public of the protections against discrimination afforded to them by Title II of the ADA, including information about how Title II requirements apply to its particular programs, services and activities [28 C.F.R. § 35.106]. A public entity also is required to provide an opportunity for interested persons, including individuals with disabilities or organizations representing individuals with disabilities, to participate in the development of policies and procedures that affect the implementation of an ADA transition plan by submitting comments and making specific recommendations.

A public entity that employs 50 or more persons is required by the ADA to adopt and publish grievance procedures providing for prompt and equitable resolution of complaints or grievances alleging any action that would be prohibited by Title II of the ADA. The City's grievance procedure is described below. Any person with a disability or any parent or guardian who represents a minor person with a disability, who believes that they have been the subject of disability-related discrimination on the basis of the denial of access to facilities, programs or services, may file a grievance or complaint.

Grievance Procedures and Instructions

Step 1: File a Grievance Form

The complainant should fill out the ADA Complaint / Grievance Form shown below, giving all of the information requested. The ADA Complaint / Grievance Form should be filed in writing with the ADA Program Access Coordinator within 60 days of the alleged disability-related discrimination. Upon request, reasonable accommodations will be provided in completing the form, or alternative formats of the form will be provided. The ADA Complaint / Grievance Procedure and Form may be obtained from and sent to the City of Rancho Cordova, ADA Program Access Coordinator, 3121 Gold Canal Drive, Rancho Cordova, CA 95670, Telephone: (916) 942-0222, Fax: (916) 853-1691, E-mail: kgarcia@cityofranhocordova.org, TTY (916) 942-0226.

Step 2: An Investigation is Conducted

A notice of receipt shall be mailed to the complainant by registered mail within five days of the receipt of the complaint or grievance, and the ADA Program Access Coordinator or another authorized representative shall begin an investigation into the merits of the complaint within 60 days. If necessary, the ADA Program Access Coordinator or another authorized representative may contact the complainant directly to obtain additional facts or documentation relevant to the grievance. If the complainant alleges misconduct on the part of the ADA Program Access Coordinator, another authorized representative may be appointed by the City Engineer to undertake the investigation if the allegations can be

substantiated. If the complainant does not wish to be contacted personally, he/she should indicate it on the ADA Complaint / Grievance Form.

After the grievance is received, the complaint shall be brought before the ADA Oversight Committee, chaired by the ADA Program Access Coordinator.

Step 3: A Written Decision is Prepared and Forwarded to the Complainant

The ADA Program Access Coordinator shall prepare a written decision, after full consideration of the grievance merits, no later than 75 days following the receipt of the grievance. If the complaint alleges misconduct on the part of the ADA Program Access Coordinator, another authorized representative may be appointed by the City Engineer to prepare the written decision if the allegations can be substantiated. A copy of the written decision shall be mailed to the complainant by registered mail no later than five days after preparation of the written decision.

Step 4: A Complainant May Appeal the Decision

If the complainant is dissatisfied with the written decision, the complainant may file a written appeal with the City Engineer no later than 30 days from the date that the decision was mailed. The appeal must contain a statement of the reasons why the complainant is dissatisfied with the written decision, and must be signed by the complainant, or by someone authorized to sign on the complainant's behalf. A notice of receipt shall be mailed to the complainant by registered mail within five days of the receipt of the appeal. The appeal reviewers, consisting of the ADA Program Access Coordinator the City Engineer and other members of the ADA Oversight Committee, shall act upon the appeal no later than 60 days after receipt, and a copy of the appeal reviewers' written decision shall be mailed to the complainant by registered mail no later than five days after preparation of the decision. The decision of the appeal reviewer shall be final.

The ADA Program Access Coordinator, the City Engineer and other members of the ADA Oversight Committee shall maintain the confidentiality of all files and records relating to grievances filed, unless disclosure is authorized or required by law. Any retaliation, coercion, intimidation, threat, interference or harassment for the filing of a grievance, or used to restrain a complainant from filing, is prohibited and should be reported immediately to the ADA Program Access Coordinator or other members of the Oversight Committee depending on the case.

City of Rancho Cordova - ADA Complaint / Grievance Form

Complainant: _____

Person Preparing Complaint (if different from Complainant): _____

Relationship to Complainant (if different from Complainant): _____

Street Address & Apt. No.: _____

City: _____ State: _____ Zip: _____

Phone: (_____) _____ E-mail: _____

Please provide a complete description of the specific complaint or grievance:

Please specify any location(s) related to the complaint or grievance (if applicable):

Please state what you think should be done to resolve the complaint or grievance:

Please attach additional pages as needed.

Please do not contact me personally.

Signature: _____ Date: _____

Return to: City of Rancho Cordova, ADA Program Access Coordinator, 3121 Gold Canal Drive, Rancho Cordova, 95670

Upon request, reasonable accommodation will be provided in completing this form, or copies of the form will be provided in alternative formats. Contact the ADA Program Access Coordinator at the address listed above, via telephone (916) 942-0222, fax (916) 853-1691, e-mail: kgarcia@cityofranhocordova.org or TTY (916) 942-0226.

Section 3.6: ADA Transition Plan Oversight Committee

Introduction

A key to ensuring timely and effective implementation of the City's ADA Transition Plan is coordination among the various departments, divisions, offices and committees involved in this effort. To this end, an ADA Transition Plan Oversight Committee, chaired by the ADA Program Access Coordinator, shall be established. Its purpose is to assure that a reasonable work schedule is maintained and to monitor any additional work or costs as they are identified. The Committee should meet, at a minimum, quarterly and report annually to the Rancho Cordova City Council on the status of ADA and accessibility improvements to the public right-of-way, as well as on costs incurred to date and projected cost estimates for other components of the ADA Transition Plan. A Committee representative also should meet with the City's Pedestrian Advisory Committee, as described in Section 6.4, on a quarterly basis.

The recommended composition of the committee is as follows:

- City Engineer, City of Rancho Cordova.
- Chief Building Official, City of Rancho Cordova.
- ADA Program Access Coordinator, City of Rancho Cordova.

The Oversight Committee should evaluate the need for additional funding and look for new funding opportunities, including funding to assist with the tasks performed by the ADA Transition Plan Oversight Committee.

Specific tasks that the ADA Transition Plan Oversight Committee should undertake and oversee would include the following:

(1) Curbs and Curb Ramps Evaluation

The Oversight Committee should monitor the status of curb ramp construction, and should recommend revisions/modifications to the policy to implement the ADA Transition Plan, to handle public requests, to discuss variances and deviations to the standards and to determine technical infeasibility.

The Committee should evaluate the City's current curb ramp designs on an on-going basis to ensure that they provide the appropriate degree of access, in accordance with the ADA Codes and Standards included in the ADA Transition Plan. Where the public right-of-way allows, alternative curb ramp designs should be investigated to ensure the appropriate complying level of access. Information from the Public Right-of-way Advisory Committee of the U. S. Access Board should be continually evaluated for purposes of determining that current curb ramp designs reflect the latest access trends. Current studies and code changes related to State of California Title 24 also should be closely monitored.

(2) Individual Intersection Curbs, Sidewalks and Pedestrian Islands Evaluation

The Oversight Committee should review the monitor curbs, sidewalks and pedestrian island construction, and should recommend revisions/modifications to the policy to implement the ADA Transition Plan, to handle public requests, to discuss variances and deviations to the standards, and to determine technical infeasibility. The on-going retrofitting of curbs, sidewalks and pedestrian islands should be in accordance with the ADA Transition Plan and all applicable federal and state laws and regulations, with the highest priority first and the lowest priority last.

Areas around bus stops, transportation, public and medical facilities, shopping areas and other facilities should have the highest priority. When a curb ramp is evaluated for construction or reconstruction, the whole intersection should be evaluated for safety and usability by persons with disabilities to determine usable paths of travel.

(3) Accessible Pedestrian Signals Evaluation

The Oversight Committee should monitor accessible pedestrian signal installation and recommend revisions/modifications to the policy to implement the ADA Transition Plan. When accessible pedestrian signals are installed, they should be equipped with all features that are required by the ADA Codes and Standards, and should be in compliance with the outlined policy. Accessible pedestrian signal installations also should be evaluated to reflect any new Federal guidelines contained in the FHWA Manual on Uniform Traffic Control Devices, along with advances in accessible signal technology.

(4) Tactile Guidestrips Evaluation

The Oversight Committee should oversee the needs for tactile guidestrip installation and should recommend revisions/modifications to the policy in cooperation with the Pedestrian Advisory Committee.

(5) Private Developers' Improvements Evaluation

The ADA Transition Plan Oversight Committee should obtain from the City's Planning Department proposed plans for private developments, both residential and commercial, and evaluate the scope and impact of such plans on access improvements to streets and sidewalks in unincorporated areas.

The Committee should, through the Planning Department, identify private projects, both residential and commercial, either completed or planned, where the City retains sufficient right-of-way options to provide enhanced access improvements, such as the installation of sidewalks. Distinction should be made between those private developments where the responsibility for access improvements rests with the developer, and those situations where the City has granted variances to developers on access improvements. Where the City has allowed a variance that impacts access for the disabled, the variance should be looked at to determine if the City preserves the

option to do future improvements such as installing sidewalks. On an as-needed basis, a representative of the Planning Department should be included in the Oversight Committee to discuss Council approved variances for access improvements.

Section 4: Inventory Methodology and Findings

Section 4.1: Purpose and Summary of the Inventory Effort

The purpose of the inventory is to show a baseline of existing pedestrian facilities in the City of Rancho Cordova. These data were used to improve pedestrian facilities and to comply with ADA and Title 24 requirements and City approved policies.

The City has a wide variety of facilities within the public right-of-way. These facilities include streets and roadways, vehicular and pedestrian bridges, underground and above-ground utilities, vehicular and pedestrian signal systems, signage systems, on-street parking facilities, walkways, sidewalks with curb ramps at intersections, improved planting strips, buffers, and pedestrian activity areas, and unimproved open spaces or natural areas. The goal of the overall project is to optimize the pedestrian experience and to provide safe and usable pedestrian facilities for all pedestrians in Rancho Cordova, and to assure compliance with all federal, state, and local regulations and standards.

A five-month long period of surveying pedestrian facilities was undertaken to document existing conditions within the public rights-of-way. Surveying, as used in this section, refers to visiting the particular location by a trained accessibility surveyor, and obtaining measurements, dimensions, gradients or other visual determinations as may be appropriate depending on the particular location.

Highlights of the survey process and inventory findings pertinent to the City are listed below:

- Approximately 72 miles of streets and roadways covering over 578 individual segments of roadway boundaries were traveled and surveyed to document physical conditions along the roadways, including conditions that might be barriers to persons with disabilities.
- The inventory focused on more heavily used roadways and intersections and on those roadways and intersections serving governmental, public service and commercial uses.
- For roadways surveyed, approximately 85 percent of City roadways have sidewalks on one or both sides, and 15 percent do not have sidewalks on either side of the street.
- Approximately 718 intersections or 1,685 street corners were surveyed, and measurements were taken for a variety of dimensions and gradients.
- Approximately 73 percent of all corners surveyed have rolled curbs, approximately 19 percent have vertical curbs, and 7 percent do not have curbs.
- Approximately 27 percent of all developed corners have curb ramps. Of these, approximately 58 percent were older perpendicular curb ramps with flared sides and approximately 38 percent were newer parallel pan-type curb ramps.

- Approximately three walkways leading to schools or park are not ADA compliant (Figure 1).



Figure 1: Walkway Examples

Moraine Court Walkway adjacent to Cordova Gardens School (left)
Van Nuys Way Walkway adjacent to Riverview School (center)
Atwood Drive Walkway at Ahlstron Park (right)

Section 4.2. Inventory Methodology

Field surveying began on June 3, 2002 and ended on November 8, 2002. During this five-month period, a total of 23 surveyors spent a total of over 9,000 hours collecting detailed measurements and other data within the unincorporated County. Each surveyor underwent at least 80 hours of training on equipment, data collection methods, procedures and ADA principles, including class and in-field instruction. Surveyors followed the procedures outlined in the previously submitted and approved *Surveyor's Manual*. Two full-time supervisors spent an additional 1,700 hours directing the surveyors' efforts, including preparing survey routes, handling assignments and personnel matters, answering questions and spot checking surveyors' completed data.

Prior to beginning all survey work, surveyors were given time goals to complete each type of survey. Time records for all surveyors and their activities were kept by supervisors throughout the survey process, and surveyors as a group met their time allotments to keep the project on schedule. All data for intersections and roadways were collected using personal digital assistants (PDA's) by Handspring. Surveyors typically worked in teams of two persons, with one person being the lead driver and navigator and the other person being the main PDA operator. Both surveyors would take measurements and collect data. Most teams worked either solely on intersections or on roadways, although a few teams worked on both aspects of data collection.

Completed data were downloaded into the master database program at regular intervals, usually at the end of each week, using Pendragon database software. Data were consolidated into tables sorted by data types, stored on compact disks, and transferred into the Microsoft Access database described in Section 4.6.

Section 4.3: Summary of Areas Surveyed and Priorities

All intersections and roadway segments in the survey area were classified as Priority Level 1 (High Priority), Priority Level 2 (Medium Priority) or Priority Level 3 (Lower Priority) based upon the criteria contained in these documents. A summary of these priorities and a description of each are as follows:

High Priority Intersections and Roadway Segments (Priority Level 1)

- ◆ Major roadways (Arterials or thoroughfares with a minimum 80-foot wide right-of-way) and intersections along these arterials or thoroughfares;
- ◆ Intersections and roadway segments serving Level 1 facilities including:
 - County-owned facilities;
 - Public schools (approximately one-quarter mile radius for the main streets);
 - Hospitals, health clinics and health centers (public and private);
 - Public housing and homeless shelters, including senior facilities and rehabilitation facilities;
 - Sheriff's facilities;
 - Transportation hubs (includes bus lines and transit stations);
 - Department of Motor Vehicles offices;
 - County parks; and
 - Prisons.

For these high priority intersections and roadway segments, surveyors measured a variety of detailed accessibility and pedestrian data, as described in Section 4.4.

Medium Priority Intersections and Roadway Segments (Priority Level 2)

- ◆ Collectors (streets with minimum 60-wide right-of-way) and other roadways, and intersections along these highways;
- ◆ Intersections and roadway segments serving Level 2 facilities including:
 - Shopping malls, supermarkets and strip retail centers;
 - Major employment sites; and
 - Housing complexes, including apartments.

For these medium priority intersections and roadway segments, surveyors also usually measured a detailed variety of accessibility and pedestrian data.

Lower Priority Intersections and Roadway Segments (Priority Level 3)

- Single-family residential areas;

- Industrial areas; and
- Other areas not classified as Priority Level 1 and 2.

For the ADA Transition Plan, lower priority intersections were surveyed using either the detailed survey or a simplified survey, specially designed to gather basic data. For these simplified surveys, surveyors were trained to visually inspect intersection elements to make a basic and objective determination of the overall compliance of the various elements, but did not collect all detailed data collection items if these data were not critical to the determination of overall compliance.

The survey team used the following criteria to determine which intersections in residential areas were surveyed using detailed measurements:

- Construction year of the adjacent land uses. For example, intersections and roadway segments within a specific subdivision are expected to be built with similar standards. These subdivisions were spot-checked to verify original assumptions;
- Geographic equity using zip codes: The survey team covered the City in an equitable manner;
- Highest pedestrian collision intersections; and
- Disabled person density using Paratransit, Inc.'s dataset of 8,000 active riders.

Section 4.4: ADA Data Collection Items

For detailed measurements at or near intersections, the survey team collected and analyzed the following data:

Crosswalks: Whether crosswalks are present at any or all crossings. If present, the width, type, alignment, presence of tactile guidestrips, presence of islands and disabled access.

Curb Ramps: Whether existing curb ramp(s) are present at any of the corners within the intersection (Figure 2).

Figure 2: Curb Ramp Needs Example - Winn Elementary School on Vanguard Dr and Jupiter Dr

Directional Corner of Intersection: NE, SE, SW and NW. (Note: All corners will be referred to by one of these compass points. If the street is not perfectly aligned north and south, the direction will be assigned within the nearest 45 degrees.)

Intersection Geometry: Whether the intersection is standard right angle, T-shaped, Y-shaped, skewed, or any other irregular geometry. Whether there are pedestrian island(s) or right turn lanes.

Islands: If present, then presence of curb ramps and push buttons.

Obstructions and Obstacles: The general presence and nature of abrupt changes in sidewalk level of greater than one-half inch, paving obstructions or accessibility obstacles immediately adjacent to the corner. The following obstacles near a corner will be recorded: utility pole, traffic light pole, drain inlet, fire hydrant, street furniture and newsstand. (Figure 3)



Figure 3: Utility Pole Obstruction Examples - Mather Field Road at the Mather Sports Complex and Senior Center

Pedestrian Signals: Whether visual or accessible pedestrian signals are present. If present, the type, size, height and location of actuator buttons. The location parameters are “at curb,” “on landing,” “on ramp slope – arm length” and “on ramp slope – not arm length.” Another location question asks if the pedestrian push button is parallel to the crosswalk alignment.

Sidewalk Present: Whether a sidewalk leading to and from the curb is present. If present, the paved sidewalk width at the intersection.

Tactile Guidestrips: Whether tactile guidestrips are present at any crosswalk. If present, the location, height, width and color of the tactile guidestrips.

Traffic Control: Whether traffic signals, stop signs (all way vs. two-way vs. one-way), yield control, roundabout or no control.

Transit Stop Type: The parameters of the transit stop type are none, light rail, bus and other (Figure 4).



Figure 4: Bus Stop Path-of-Travel Example - Folsom Blvd and Routier Rd

If a curb ramp is not present at a particular corner, the following data was collected:

Curb Type: Whether a curb is present, and if present, the type (vertical or rolled).

Flush Corner: If there is no curb, whether a flush transition from the street to the sidewalk is present.

If a curb ramp is present (either one or two at a corner), the following data was collected for each curb ramp:

Car Obstruction: Curb ramp not located so that it could be obstructed by parked vehicle.

Common Landing: Dimensions of any common landing for two curb ramps.

Curb Ramp Type: A general description of the curb ramp: flared, pan, chute, blended corner or built-up.

Detectable Warnings/Truncated Domes: Whether truncated domes are present. If present, the dome location, size, type (e.g., plastic, concrete, concrete tile, brick or other) and color. Truncated domes are placed at level landings to alert visually-impaired individuals of a transition between the sidewalk and the street or railroad tracks.

Grooved Border: Whether a 12 inch grooved border around all sides is present and its width.

Gutter Slope: Slope in percent of the gutter or street transition.

Lip: Whether a lip is present at the bottom of the curb ramp, and if present, the height to the nearest 0.25 inch.

Location in Crosswalk: Curb ramp wholly contained in marked crosswalk, if applicable.

Main Slope: Main slope of the curb ramp or level landing in percent adjacent to and perpendicular to the street.

Main Cross Slope: Cross slope of the main slope of the curb ramp or level landing, parallel to the street. The cross slope is perpendicular to the main slope of a curb ramp.

Side Slope(s): Whether a side slope or parallel slope is present, and if present, the slope of each sloping side or flare parallel to the street in percent.

Slip-resistant Surface: Whether or not the surface is slip-resistant.

Street the curb ramp is facing, or if facing the intersection (diagonal).

Top Landing Depth: Whether a 48 inch deep level landing is provided at the top of the curb ramp, or at the top of each slope of a parallel curb ramp.

Transition Slope: Slope of the transition to the sidewalk, verifying slope of five percent or less for the right and left sides.

Width: Width of the curb ramp or pan. A pan or level landing exists when there is a lack of vertical separation between the sidewalk and the street.

Section 4.5 Inventory Findings

Listed in this section are basic statistics for the survey findings in Rancho Cordova. These statistics generally include only citywide statistics and not a detailed analysis of the findings. Where the maximum allowable dimensions or gradients are noted for specific elements, these dimensions are the proposed standards for new construction.

Intersection Survey Statistics

Total number of intersections: **718**
 The survey records include partially completed intersection information.

Total number of all corners: **1,685**

Corner Statistics

Types of corners

Curb Type	Count	%
Rolled	1215	73%
Vertical	315	19%
No Curb	121	7%
Flush Transition	8	0%
Total	1659	

Corners with sidewalks at corners

Sidewalk Present	Count	%
N	198	12%
Y	1461	88%
Total	1659	

Average sidewalk width at corners: 52.98 in.

Corners with sidewalks with changes in level or gaps greater than ½"

Changes In Level	Count	%
N	1324	80%
Y	335	20%
Total	1659	

Corners with sidewalk obstacles limiting access:

Obstacles Near Corner	Count	%
No Obstacle	1099	66.2%
Drain Inlet	438	26.4%
Drain Inlet;Landscaping	34	2.0%
Fire Hydrant	1	0.1%
Landscaping	61	3.7%
Other	8	0.5%
Street Furniture	1	0.1%
Traffic Light Pole	7	0.4%
Traffic Light Pole;Drain Inlet	2	0.1%
Utility Pole	3	0.2%
Utility Pole;Drain Inlet	2	0.1%
Utility Pole;Drain Inlet		
Inlet;Landscaping	1	0.1%
Utility Pole;Landscaping	1	0.1%
Utility Pole;Traffic Light Pole	1	0.1%
Total	1659	

Curb Ramp Statistics

Number of Curb Ramps Surveyed: 451

Types of curb ramps

Ramp Style	Count	%
Flared/Perpendicular (with side slopes)	261	58%
Pan/Parallel (landing level with street)	170	38%
Chute	15	3%
Other	4	1%
Blended Corner	1	0%
Total	451	

Gutter slopes at curb ramps (5% maximum allowed):

Less than or equal to 5%	120	26%
Greater than 5%	314	70%
Greater than 7%	147	33%
Total	451	

Main slopes on curb ramps (8.33% maximum allowed):

Less than or equal to 8.33%	255	57%
Greater than 8.33%	179	40%
Greater than 10%	117	26%
Total	451	

Cross slopes on curb ramps (2% maximum allowed):

Less than or equal to 2%	297	66%
Greater than 2%	137	30%
Greater than 3%	65	14%
Total	451	

Side slopes on perpendicular / flared curb ramps (10% maximum allowed)

Less than or equal to 10%	242	54%
Greater than 10%	192	43%
Greater than 12%	104	23%
Total	451	

Widths of curb ramps (48" minimum preferred)

Less than or equal to 36"	9	2%
Less than 48"	28	6%
Greater or Equal to 48"	415	92%
Total	451	

Beveled lip height on curb ramps (no lip preferred, 1/2" max.)

Lip Height	Count	%
No response	5	1%
0	223	49%
0.05	7	2%
0.25	88	20%
0.5	69	15%
0.75	20	4%
1	27	6%
1.25	2	0%
1.5	1	0%
2	8	2%
3	1	0%
Total	451	

Grooved borders on curb ramps (12" grooved border preferred)

Curb ramps with grooved border: 56%
 Curb ramps without grooved border: 44%

Curb ramps with top landing for perpendicular / flared curb ramps, where top landing is required (48" minimum)

Greater than or equal to 48": 47%
 Less than 48": 53%

Curb ramps with truncated domes

Without truncated domes: 94%
 With truncated domes: 6%

Crosswalk Statistics

Number of Crosswalks Surveyed 167

Types of intersections with crosswalks:

Traffic Control	Count	%
Traffic Signals	105	63%
No Control	22	13%
4-Way Stop	3	2%
3-Way Stop	14	8%
2-Way Stop	11	7%
1-Way Stop	12	7%
Total	167	

Types of crosswalks:

Crosswalk Type	Count	%
Yellow Lines; Ladder Pattern	11	7%
Yellow Lines, parallel	31	19%
White Lines; Ladder Pattern	1	1%
White Lines, parallel	104	62%
Other (diagonal stripes)	20	12%
Total	167	

Width of crosswalks (96" minimum required)

Greater than or equal to 96":	72%
Less than 96":	28%

Number of crosswalks with crooked alignment:

Without crooked alignment:	96%
With crooked alignment:	4%
With tactile guidestrips installed (if crooked alignment):	0%

Pedestrian Signal Statistics

Number of Pedestrian Signals Surveyed **270**

Signalized intersections with accessible pedestrian signals: 11.0%
(where pedestrian signals are present)

Push Button Type	Count	%
Other	32	12%
Visual	208	77%
Visual and Audible	30	11%
Total	270	

Pedestrian signal push button sizes (2" preferred)

With ½" diameter push buttons:	77.0%
With 2" diameter push buttons:	23.0%

Push button heights (48" preferred, 54" maximum)

Less than or equal to 48" height:	84%
Between 48" and 54" height:	15%
Greater than 54" height:	1%

Roadway / Sidewalk Survey Statistics

Total miles of roadway: 72 miles approx.

Total number of roadway segments: 578

Roadway lane configurations

Lane Config.	Total	%
Center Turning Lane	44	8%
Divided	57	10%
Undivided	477	83%
Total	578	

Number of lanes on roadways

Lanes	Total	%
2	474	82%
4	67	12%
5	5	1%
6	32	6%
Total	578	

Percentage of sidewalk coverage,

Sidewalk %	Total	%
0	100	15%
25	7	1%
50	6	1%
75	10	2%
100	538	81%

Average sidewalk width, when present: 4.3 ft.

Sidewalk condition, when present:

Sidewalk Condition	Total	%
1 worse	18	3%
2	14	2%
3	504	87%
4	21	4%
5 Best	17	3%
No Data	5	1%

Number of fixed obstructions (reducing width to less than 48") along sidewalk

Fixed Obstruction	Total	%
0	329	73
1	98	22
2	12	3
3	4	1
4	5	1
5	1	0
7	1	0
Total	450	100%

Number of non-fixed obstructions (reducing width to less than 48") along sidewalk

Non Fixed Obstruction	Total	%
0	312	66
1	125	27
2	24	5
3	3	1
4	6	1
9	1	0
Total	471	100%

Percentage of sidewalks segments with level changes > 1/2"

No level changes: 51%
 1 or more level changes: 49%

Types of curb along roadway segments

Rolled curb: 78%
 Vertical curb: 16%
 No curb (open shoulder): 6%

Percentage of shoulder types, where no curb or sidewalk is present

<u>Shoulder</u>	<u>Count</u>
Ditch or Canal	13
Flat	38
Swale	17

Percentage of roadway segments with parking allowed

Parking allowed: 72%
 No parking: 28%

Type of parking (where allowed)

Parallel: 99.3%
 Angled/Diagonal: 0.7%

Percentage of occupied parking, where parking is allowed

<u>Occupied %</u>	<u>%</u>
0	67%
25	26%
50	4%
75	1%
100	1%

Total number of transit stops: 78

<u>Transit Stop</u>	<u>Count</u>
Bus	77
Light Rail	1
None	1071

Number of transit stops with cross-slope pad > 3%: 32

Number of bus shelters: 6

Section 4.6: ADA Public Rights-of-Way Database Preparation and Contents

All survey findings are contained in a Microsoft Access database. The database is designed to be user-friendly, with interactive screens available to access the summary report and reports for each individual intersection or roadway segment. When the database is opened, a "welcome" screen guides the user through a series of buttons, which access the next layer of screens. An "Intersections" or "Roadway" button opens a search screen for finding data for each particular intersection or roadway segment. Data for a specific intersection or roadway segment may be found by either finding a street name or by selecting the intersection ID number. A series of one-page reports are available through buttons on the screen.



It should be noted that for those experienced in using and programming Microsoft Access, all data stored in tables and all queries, forms, and reports that manage the presentation of the data are available by opening the "database window". Nevertheless, for those inexperienced in using Access, it should be noted that such usage is not recommended, since data can be easily erased or altered if incorrect procedures are used.

Section 5: ADA Codes and Standards

Introduction

The ADA Codes and Standards were developed as part of an extensive process to propose applicable guidelines, codes and standards as they relate to the accessibility of all facilities within the public right-of-way. The ADA Codes and Standards went through a total of three versions. The TAC and ADA CAG reviewed and provided input to each version.

The first draft of an ADA Codes and Standards Matrix was presented to SacDOT, the ADA CAG and the TAC on May 6, 2002. Based upon comments from all parties received verbally at subsequent meetings, a second draft of the ADA Codes and Standards Matrix was submitted to SacDOT, the ADA CAG and the TAC on November 22, 2002. All parties then were asked to provide written comments on the standards by December 31, 2002. A total of 16 separate response documents were received. All comments from respondents (including some comments received after the December 31, 2002 date) were analyzed by the study team and considered in the preparation of the final draft document. The final draft document was completed and submitted for review on April 25, 2003, and it was reviewed at ADA CAG and TAC meetings on June 2, 2003.

The ADA Codes and Standards were developed to combine and resolve any conflicts between the Americans with Disabilities Act Accessibility Guidelines (ADAAG), published by the U.S. Architectural and Transportation Barriers Compliance Board in July 1991, and the California State Building Code, Title 24, Part 2, of the California Code of Regulation, 2001 edition. Draft Guidelines for Public Rights-of-Way, published by the U.S. Architectural and Transportation Barriers Compliance Board on June 17, 2002, which are expected to take effect in the near future, also were considered, but not necessarily replicated, in the ADA Codes and Standards described in this section. In addition, all County of Sacramento Board of Supervisor approved policies and standards affecting accessibility in the public right-of way were included in the ADA Codes and Standards.

The ADA Codes and Standards described in this section are intended to apply to all construction undertaken with the City right-of way after the final approval of the ADA Transition Plan. The codes and standards would include all new development and all construction undertaken as part of the ADA Capital Implementation Plan included in Section 6.

Appendix B illustrates the Standard Improvement Drawings for curb ramps, sidewalks, driveways, bus stops and other applicable issues.

Section 5.1: Applicability of City ADA Standards

This section describes how the ADA codes and standards impact City standards and procedures.

1.1 New Development: All areas of newly designed and newly constructed facilities in the City-regulated public right-of-way shall comply with these standards.

1.2 Additions in the Existing Public Right-of-Way: Each addition to an existing City-regulated public right-of-way shall comply with the applicable provisions of these standards. Where the addition connects with existing construction, the connection shall comply with Alterations, as described in the next subsection.

1.3 Alterations in the Existing Public Right-of-Way: Where existing elements or spaces in the City-regulated public right-of-way are altered, each altered element or space shall comply with the applicable provisions of these standards.

1.3.1 Exception: In alterations, where compliance with applicable provisions is technically infeasible, the alteration shall comply to the maximum extent feasible.

1.3.2 Prohibited Reduction in Access. An alteration that decreases or has the effect of decreasing the accessibility of a public right-of-way or site arrival points to buildings or facilities adjacent to the altered portion of the public right-of-way, below the requirements for new construction at the time that the alteration is prohibited.

1.4 Approval Procedures for Exceptions, Equivalent Facilitation and Technically Infeasible Conditions:

The City shall appoint an ADA Program Access Coordinator, whose main duties are to review all aspects of compliance with the ADA Codes and Standards contained in this document. The ADA Program Access Coordinator shall report directly to the City Engineer, and the City Engineer may delegate such approval authority and responsibility contained in these standards to the ADA Program Access Coordinator, as he/she determines to be appropriate.

1.5 Dimensional Tolerances: All dimensions and numerical requirements contained in these standards are absolute and requirements have been derived taking into account construction practices and constraints, and no dimensional tolerances beyond the maximum or minimum dimensions are allowed, unless otherwise stated.

1.5.1 Advisory: It is advised that designers use numerical criteria in designs and specifications that are below the maximum or are above the minimum requirements stated in these standards, so that the final constructed improvements meet the stated requirements.

1.6 Inclusion and Incorporation into Existing City Improvement Standards:

The intent of the listing of these standards is that all standards will be included and incorporated into the City's Improvement Standards, Section 4 - Streets.

Where parentheses follow a specific standard, the number refers to the specific current City Improvement Standard sections that correspond to the specific requirements and in which the new standards will be included or incorporated.

Standard City Improvement Drawings also may be referenced as part of these standards (Appendix B). Written requirements as included in these standards shall take precedence over any drawings should there be any discrepancies in the requirements.

1.7 Future Applicable Federal and State Code Revisions: All future enactments and revisions to legally applicable Federal or State accessibility codes, standards or guidelines, such as the ADA Accessibility Guidelines or Title 24 of the California Code of regulation, shall be incorporated into these ADA Codes and Standards to the extent that such enactments or revisions exceed the requirements contained herein. Nevertheless, such enactments or revisions shall not decrease any requirement as contained herein.

Section 5.2: Applicable Reference Codes and Standards

The following codes and standards are referenced as applicable by law or statute. Nothing in these standards shall have the effect of reducing any specific requirements of the referenced standards (1) or (3), or any other codes or standards required by applicable law or statute. Should other new codes or standards become applicable law or statute after the adoption of these standards, such new codes or standards shall supercede these standards, but only to the extent that new codes or standards are more restrictive or exceed these standards.

(1) **The Americans with Disabilities Act Accessibility Guidelines (ADAAG)**, published by the U.S. Architectural and Transportation Barriers Compliance Board in July 1991, binding regulatory law in 1992, with several revisions through July 1998. (Note: Some jurisdictions mistakenly use a revised edition of these standards dated September 1994; this edition was never approved and should NOT be used.) The ADAAG guidelines were written to apply to newly constructed places of public accommodation. The ADAAG is an appendix to Title III of the ADA. The technical standards of the ADAAG also provide a technical definition for accessible elements. These guidelines were not written to specifically apply to public facilities, which must provide equal access to people with disabilities to all programs and services of local and state governments. Therefore, while meeting the technical requirements of the ADAAG assures owners of places of public accommodation of full compliance with the ADA, such technical compliance may not be sufficient to provide full access to programs and services for government entities.

(2) **Draft Guidelines for Public Rights-of-Way**, published by the U.S. Architectural and Transportation Barriers Compliance Board on June 17, 2002. These guidelines are currently out for public review and are intended to replace the current ADAAG guidelines listed in (1) in the future. The guidelines have not been approved, but are represented to be the most current state-of-the-art with respect to accessibility in the public right-of-way. The guidelines also were written to apply to new construction. The extent to which they should be applied to major alterations and retrofits is still under review by the Access Board, and is scheduled to be the subject of a technical assistance manual due for release in 2004.

(3) **California State Building Code, Title 24, Part 2**, of the California Code of Regulation, 2001 edition. These code requirements apply to any actual construction work within the public right-of-way at the time that the work is constructed, but the requirements of Title 24 are limited to the actual work being constructed and do not apply to adjacent areas beyond the construction limits.

(4) **Current City Improvement Standards**, including (a) Sacramento County Design Improvement Standards for Streets, Sections 4-1 through 4-33, June 11, 2003, (b) Sacramento County Policy on Street and Sidewalk Access Improvement Priorities, December, 2000, (c) Sacramento County Policy for Audible Pedestrian Signals, adopted by the Sacramento County Board of Supervisors on July 20, 1999, (d) Sacramento County

Improvement Standards for Crosswalks and Tactile Guidestrips, May 2001, (e) Sacramento County Guidestrip Policy, approved by the Board of Supervisors on August 18, 1987.

Section 5.3: Sidewalk and Pedestrian Access Standards

3.1 Scope: Where sidewalks, corners or pedestrian access paths are provided adjacent to streets or roadways within the public right-of-way, they shall meet the requirements of this section.

3.2 Clear Width: Where a sidewalk is provided adjacent to a street or roadway, each part shall provide a minimum clear width of 60 inches, not including the width of any curb that may be present between the sidewalk and the street or gutter.

3.2.1 Exception: All frontages directly in front of all school properties shall have a clear width of 96 inches, except frontages in front of fenced play areas with no access may have a clear width of 72 inches.

3.2.2 Exception: Where existing conditions or obstructions or reduced right-of-way widths preclude providing a 48 inch clear width, the sidewalk width may be reduced to less than 48 inches for a distance not exceeding 24 inches, but in no case shall the clear width be less than 36 inches.

3.2.3 Advisory: For streets or roadways with a right-of-way width of 84 feet or greater, a minimum clear width of 72 inches is preferred.

3.3 Passing Space: If a sidewalk has less than 60 inches clear width, a passing space of at least 60 inches by 60 inches shall be located at reasonable intervals not to exceed 200 feet.

3.3.1 Exception: Where existing conditions or reduced right-of-way width preclude providing a 60-inch passing space, such space shall not be required.

3.4 Cross Slope: The cross slope of the sidewalk shall be 1:67 (1.5 percent), with allowances for a construction variance of 1:200 (0.5 percent) in either direction.

3.5 Running Slope: The running slope of the sidewalk shall not exceed the grade of the adjacent roadway or 1:20 (five percent), whichever is greater.

3.6 Level Areas on Continuous Slopes: For sidewalks with a running slope exceeding five percent for at least 400 feet, a 60-inch long landing with a maximum slope of two percent shall be provided for every 400 feet of the sidewalk length, except for roadway overpasses.

3.7 Meandering Sidewalks: Sidewalks may be separated from the curb by approved landscaping, forming a meandering sidewalk. The distance between the back of the curb and the edge of the sidewalk shall not be less than five feet nor more than 25 feet, except at transitions. If trees are planted between the back of the curb and the edge of the sidewalk, the distance between the back of the curb and the edge of the sidewalk shall not be less

than five feet. Meandering sidewalks shall comply with the requirements of either Case I or Case II, as described below.

For Case I, the sidewalk shall have a 24-inch wide minimum straight path along the sidewalk. For Case II, the sidewalk shall have no abrupt changes of direction and shall be constructed using only tangents of any length and inside radii of at least 150 feet. Refer to Standard Drawing 4-29 (Appendix B).

3.8 Curbs at Streets Adjacent to Sidewalks: Curbs on the street side of sidewalks and corners shall be approximately vertical, with a height of at least five inches but no greater than eight inches.

3.8.1 Exception: Where a new portion of curb is constructed within an existing system of rolled curbs and existing drainage patterns must be maintained, a rolled curb matching the existing curb may be constructed. This exception shall not apply to a transit stop location, where the curb must be provided per 8.6 in Section 5.8.

3.9 Surfaces: The surface shall be either Portland cement concrete or asphalt concrete, and it shall be firm, stable and slip-resistant.

3.9.1 Exception: A material other than concrete or asphalt may be used when it can be adequately demonstrated to the ADA Program Access Coordinator that it provides an equal firm, stable and slip-resistant surface.

3.10 Changes in Level: Changes in level up to 1/4 inch may be vertical and without edge treatment. Changes in level between 1/4 inch and 1/2 inch shall be beveled with a slope no greater than one horizontal to two vertical. Changes in level greater than 1/2 inch (13 mm) shall be accomplished by means of a ramp. Multiple changes in level shall be separated horizontally by at least 30 inches.

3.11 Gratings: If gratings are located in the sidewalk surface along a pedestrian access route or in the accessible portion of a curb ramp, they shall have spaces no greater than 1/2 inch wide in the direction of travel. If gratings have elongated openings, they shall be placed so that the long dimension is perpendicular to the direction of travel. Whenever possible, drainage inlets should be located outside of the crosswalk area, particularly the portion of the crosswalks that adjoin the accessible portion of curb ramps.

3.12 Protruding Objects:

Protruding objects shall not reduce the clear width required for sidewalks.

Objects with leading edges located between 27 inches above and 80 inches below the finish surface shall protrude no more than four inches horizontally into the pedestrian access route.

Free-standing objects mounted on posts or pylons shall overhang pedestrian access routes no more than four inches when located between 27 inches above and 80 inches below the finish surface (Figure 5).

Figure 5: Barrier for Vertical Clearance Less than 80 Inches

Source: Public Rights-of-Way Access Advisory Committee, *Building A True Community*, January 2001.

Note: For alternative format, refer to the corresponding text

Where a sign or other obstruction is mounted between posts or pylons and the clear distance between post or pylons is greater than 12 inches, the lowest edge of such sign or obstruction shall be located between 27 inches above and 80 inches below above the surface, and there shall be a bar or similarly detectable element 15 inches above the surface connecting the two posts or pylons.

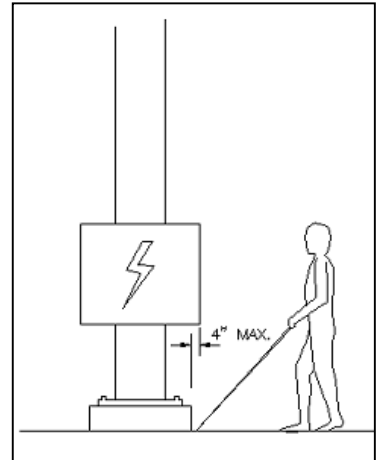

3.13 Barrier Curbs at Drop-offs:

Warning or barrier curbs shall be provided at the locations described below:

Abrupt changes in level at the edge of sidewalks, except between a sidewalk and an adjacent street, exceeding four inches in a vertical dimension, such as at planters or fountains located in or adjacent to sidewalks, shall be identified by curbs projecting at least six inches in height above the surface.

At bus stops, where a slope behind a sidewalk slopes toward the sidewalk, a barrier curb projecting at least six inches in height above the surface shall be provided to prevent water flow across the sidewalk.

Where the slope behind a sidewalk is greater than six (horizontal) to one (vertical) and the slope is away from the sidewalk, a barrier curb projecting at least six inches in height above the surface shall be provided for pedestrian safety. A retaining wall or fence may be provided in lieu of the required barrier curb.

3.14 Driveway Crossings:

Where a sidewalk crosses a driveway, the minimum width of 48 inches and the cross slope of 1:67 (1.5 percent), with allowances for a construction variance of 1:200 (0.5 percent) in either direction, shall be provided for the entire width of the driveway.

Each driveway shall have a ½-inch to one-inch lip, beveled at 45 degrees, at the street or gutter.

Driveway entries shall not be designed or used as curb ramps.

3.15 Rail Crossings:

Where a sidewalk crosses rail systems at grade, the surface of the sidewalk shall be level and flush with the top of the rail at the outer edge and between the rails.

Where a sidewalk crosses rail systems at grade, the horizontal gap at the inner edge of each rail shall be constructed to the minimum dimension necessary to allow passage of railroad car wheel flanges and shall not exceed 2½ inches (three inches for freight rails).

Where a sidewalk crosses rail systems at grade, detectable warning surfaces complying with Section 5.5 extending the full width of the sidewalk and 36 inches deep in the direction of pedestrian travel shall be provided on each side of the rails.

3.16 Stairs: To the maximum extent feasible, stairs shall not be constructed within the public right-of way.

3.16.1 Exception: If provided, steps or stairs shall provide 1.5 inch diameter handrails 34 inches to 38 inches above each nosing on both sides, with extensions at the top and bottom meeting all applicable portions of the California State Building Code, Chapter 11B. If provided, steps or stairs shall provide a two-inch contrasting yellow color stripe at each tread and the upper approach of each staircase. The contrasting color stripe shall be yellow conforming to Federal Color No. 33538, as shown in Table IV of Standard No. 595B.

Section 5.4: Curb Ramp and Blended Transition Standards

4.1 Scope: Each corner of an intersection shall be provided with two curb ramps, each oriented in the direction of pedestrian crossing to the adjacent corner, except that only one curb ramp with a six foot pan may be provided if two curb ramps are technically infeasible or excepted as described below. Curb ramps shall comply with the requirements of this section for flared sides, detectable warning devices, landings and ramps (Figure 6).

4.1.1 Exception: Where pedestrian crossing in a specific direction is prohibited by a continuous raised median, barricade or sign, no curb ramp shall be provided. Where only one curb ramp is provided at a corner to serve only one direction of travel to an adjacent corner, the curb ramp shall be aligned and oriented parallel to the intended direction of travel.

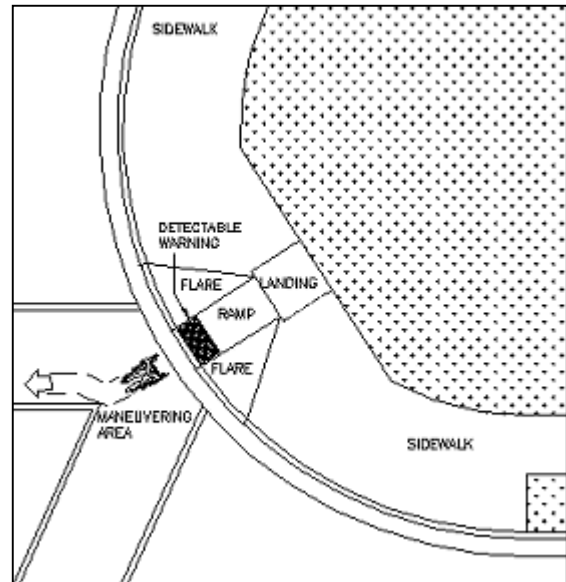

Figure 6: Curb Ramp Components

Source: Public Rights-of-Way Access Advisory Committee, *Building A True Community*, January 2001.

Note: The illustration shows the location of the ramp, flares, landing and other curb ramp features. For alternative format, refer to the corresponding text.

4.2 Curb Ramp Types: Curb ramps shall be primarily perpendicular curb ramps, as shown in Standard Drawing 4-23B (Appendix B), if there is sufficient right-of-way or sidewalk depth to construct the perpendicular curb ramp in full compliance with subsection 5.3. If there is not sufficient right-of-way or sidewalk depth to construct a perpendicular curb ramp, a parallel curb ramp, as shown in Standard Drawing 4-23A (Appendix B), may be constructed. Blended transitions shall not be constructed, unless specifically approved by the City Engineer and the ADA Program Access Coordinator.

4.3 Perpendicular Curb Ramps: Perpendicular curb ramps shall comply with the details described in this subsection, and shall have a running slope that cuts through the curb at right angles or meets the gutter grade break at right angles (Figure 7).

4.3.1 Running Slope: The running slope of the main portion of the curb ramp shall be 1:12 (8.33 percent) maximum.

4.3.1.1 Advisory: Where feasible, the minimum running slope of the main portion of the curb ramp is preferred to be 1:15 (6.67 percent).

4.3.2 Cross Slope: The cross slope of the main portion of the curb ramp shall be 1:67 (1.5 percent), with allowances for a construction variance of 1:200 (0.5 percent) in either direction.

4.3.3 Landing: A landing measuring 48 inches minimum by 48 inches minimum shall be provided at the top of the curb ramp, and shall be permitted to overlap other landings and clear spaces. Running and cross slopes of the landing shall be 1:67 (1.5 percent) maximum, with allowances for a construction variance of 1:200 (0.5 percent) in either direction.

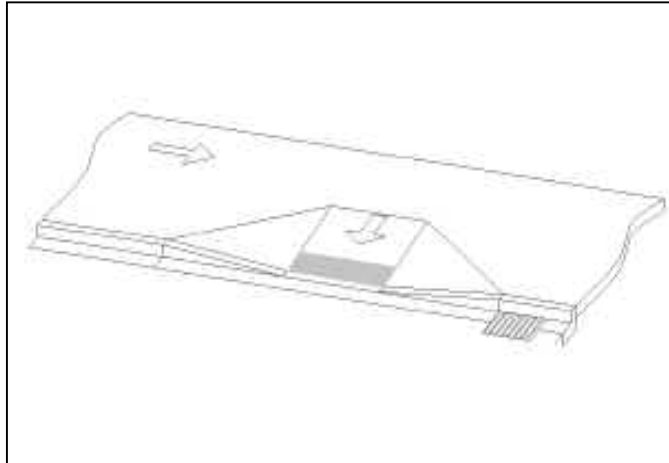

Figure 7: Perpendicular Curb Ramp

Note: For alternative format, refer to the corresponding text.

Source: www.access-board.gov/rowdraft.htm

4.3.4 Flared sides: Flared sides with a slope of 1:10 (ten percent) maximum, measured along the curb line, shall be provided where a circulation path crosses the curb ramp.

4.3.5 Clear Width: The clear width of the main portion of the curb ramp, excluding flared sides, shall be 48 inches minimum.

4.3.6 Detectable Warnings: Detectable warning surfaces complying with Section 5.5 shall be provided for the full width of the main portion of the curb ramp or blended transition, with the front edge located approximately six inches behind the curb line.

4.3.7 Grooved Border: A 12-inch wide grooved border with 1/4 inch grooves approximately 3/4 inch on center shall be provided at the top of the main slope and at the side of each side slope.

4.3.8 Surfaces: Surfaces of curb ramps and landings shall comply with Section 3.9. Gratings, access covers and other appurtenances shall not be located on curb ramps, landings and gutter areas directly in front of curb ramps.

4.3.9 Changes in Level: Vertical changes in level greater than those described in Section 3.10 shall not be permitted on curb ramps, landings or gutter areas directly in front of curb ramps.

4.3.10 Gutter Slope: The counter slope of the gutter area or street at the foot of a curb ramp or landing shall be 1:20 (five percent) maximum.

4.3.11 Clear Space: Beyond the curb line toward the street, a clear space measuring 48 inches minimum by 48 inches minimum shall be provided within any marked crosswalk that may be present and located wholly outside of the parallel vehicle travel lane.

4.3.12 Obstructions: Curb ramps shall be located or protected to prevent their obstruction by parked cars.

4.4 Parallel Curb Ramps: Parallel curb ramps shall comply with the details described in this subsection, and shall have running slopes that are in-line with the direction of sidewalk travel (Figure 8).

4.4.1 Running Slope: The running slope of each side slope shall be 1:12 (8.33 percent) maximum.

4.4.1.1 Advisory: Where feasible, the minimum running slope of each side slope is preferred to be 1:15 (6.67 percent).

4.4.2 Cross Slope: The cross slope of each side shall be 1:67 (1.5 percent), with allowances for a construction variance of 1:200 (0.5 percent) in either direction.

4.4.3 Clear Width: The clear width of each side slope shall be 48 inches minimum.

4.4.4 Landing: A landing measuring 48 inches minimum by 48 inches minimum shall be provided at the bottom of each ramp slope. Landing slopes shall be 1:100 (one percent) minimum and 1:67 (1.5 percent) maximum, with allowances for a construction variance of 1:200 (0.5 percent) in either direction.

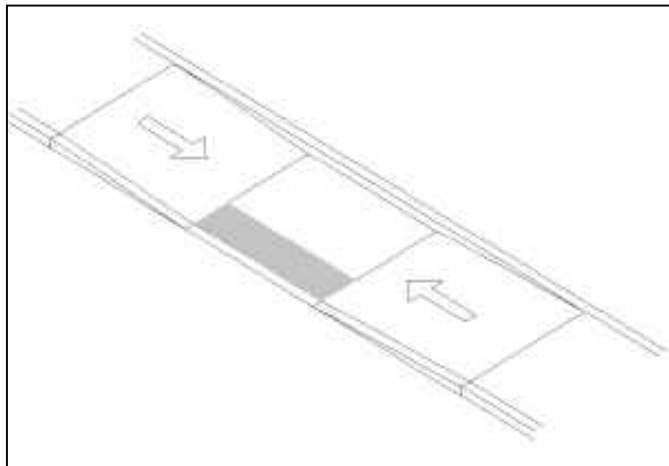

Figure 8: Parallel Curb Ramp

Note: For alternative format, refer to the corresponding text.

Source: www.access-board.gov/rowdraft.htm

4.4.5 Diverging Sidewalks: Where a parallel curb ramp does not occupy the entire width of a sidewalk, drop-offs at diverging segments shall be protected with a six-inch curb or similar barrier.

4.4.6 Common Landing Width: Where two parallel curb ramps are located at a corner, the landing between the top of each side slope shall be 48 inches minimum.

4.4.7 Detectable Warnings: Detectable warning surfaces complying with Section 5.5 shall be provided for the full width of the lower landing between the side slopes of the curb ramp, with the front edge located approximately six inches behind the curb line.

4.4.8 Grooved Border: A 12-inch wide grooved border with 1/4 inch grooves approximately 3/4 inch on center shall be provided at the top of each side slope.

4.4.9 Surfaces: Surfaces of curb ramps and landings shall comply with Section 3.9. Gratings, access covers and other appurtenances shall not be located on curb ramps, landings and gutter areas directly in front of curb ramps.

4.4.10 Changes in Level: Vertical changes in level greater than those described in Section 3.10 shall not be permitted on curb ramps, landings, or gutter areas directly in front of curb ramps.

4.4.11 Gutter Slope: The counter slope of the gutter area or street at the foot of the lower landing shall be 1:20 (five percent) maximum.

4.4.12 Clear Space: Beyond the curb line toward the street, a clear space of 48 inches minimum by 48 inches minimum shall be provided within any marked crosswalk that may be present and located wholly outside the parallel vehicle travel lane.

4.4.13 Obstructions: Curb ramps shall be located or protected to prevent their obstruction by parked cars.

Section 5.5: Detectable Warning Standards

5.1 Scope: Where detectable warnings (truncated domes) are required by other sections of these standards, they shall comply with the requirements of this section.

5.2 Size and Location: Detectable warnings shall be 36 inches in depth and span the full width of the area where they are required.

5.3 Specifications: The detectable warning surface shall be prefabricated and shall have in-line, square grid pattern truncated domes with a diameter of nominal 0.9 inch (22.9 mm) at the base tapering to 0.45 inch (11.4 mm) at the top, a height of nominal 0.2 inch (5.08 mm), and a center-to-center spacing of nominal 2.35 inches (59.7 mm). “Nominal” means that pre-manufactured detectable warnings or devices used to create the detectable warning in place shall comply with required dimensions within + - 0.020 inch for dome height, top diameter and bottom diameter and 0.050 inch for dome spacing. Detectable warnings shall be safety yellow conforming with Federal Color No. 33538, Table IV of Standard No. 595B, and with safety field dots 30 per square inch between truncated domes. The 0.2-inch height of domes shall be measured from the top of the highest field safety dot to the highest point on the top of the truncated dome. Detectable warning surfaces shall differ from adjoining walking surfaces in sound on cane contact.

Section 5.6: Pedestrian Crossing Standards

6.1 Scope: All controlled intersections shall be provided with marked crosswalks as described in this section. Controlled intersections refers to intersections with a traffic signal system or all-way stop signs. If provided, all marked crosswalks shall comply with the requirements of this section.

6.2 Width: Marked crosswalks shall be 96 inches wide minimum, as measured between the striped lines.

6.2.1 Advisory: Where feasible, marked crosswalks shall be 120 inches wide, as measured between the striped lines.

6.3 Color and Size: Crosswalk stripes shall be 12 inches wide, and white in color.

6.3.1 Exception: Crosswalks serving schools shall be yellow in color.

6.4 Advisory Cross Slope: The cross slope of the pavement within a marked crosswalk shall be 1:67 (1.5 percent) maximum, measured perpendicular to the direction of pedestrian travel, with allowances for a construction variance of 1:200 (0.5 percent) in either direction.

6.5 Running Slope: The running slope of the pavement within a marked crosswalk shall be 1:20 (five percent) maximum measured parallel to the direction of pedestrian travel in the crosswalk.

6.6 Pedestrian Signal Phase Timing: All pedestrian signal phase timing shall be calculated using a pedestrian walk speed of 3.5 feet per second maximum. To accommodate older pedestrians who may have a slower gait, pedestrian signal phase timings shall be calculated using a pedestrian walk speed of 2.8 feet per second. The locations for the slower pedestrian signal phase timings will be determined on a request basis. The total crosswalk distance used in calculating pedestrian signal phase timing shall include the entire length of the crosswalk plus the length of each curb ramp, if the curb ramp is a perpendicular curb ramp.

6.7 Medians and Pedestrian Refuge Islands: Medians and pedestrian refuge islands in crosswalks shall be cut through level with the street or have curb ramps complying with Section 5.4. Where the cut-through connects to the street, edges of the cut-through shall be aligned with the direction of the crosswalk for a length of 24 inches minimum.

6.7.1 Width: The width of all cut-throughs shall be 48 inches minimum.

6.7.1.1 Advisory: Where feasible, the width of all cut-throughs shall be 60 inches.

6.7.2 Length: Where signal timing is not designed or intended for full crossing of all traffic lanes or where the crossing is not signalized, cut-through medians and pedestrian refuge islands shall be 96 inches minimum in length in the direction of pedestrian travel.

6.7.3 Detectable Warnings: Medians and refuge islands shall have detectable warnings complying with the section titled Detectable Warnings (Section 5.5). Detectable warnings at cut-through islands shall span the full width of the cut-through and shall be separated by a 24-inch minimum length of walkway without detectable warnings.

6.8 Crosswalk Alignment: Marked crosswalks shall have straight alignment, with no change of direction between the terminal ends of the crosswalk.

6.8.1 Exception: Where a straight crosswalk is not feasible at existing intersections due to the particular geometry of the intersection, or where an intersection has unusual or non-standard geometry such as exceptionally large radii, T-intersections and intersections with exceptionally wide streets, as determined by the ADA Program Access Coordinator and the Pedestrian Advisory Committee, tactile guidestrips shall be installed within the crosswalk. Where required, a tactile guidestrip shall be located in the center of the crosswalk for the entire length of the crosswalk. The color of the tactile guidestrip shall match the crosswalk color. The tactile guidestrip material shall be a vitrified polymer composite consisting of epoxy polymer composition employing aluminum oxide particles in the raised surface of the guidestrip. The nominal dimensions of the tactile guidestrip shall be 4 inches wide by 24 inches long by 5/16 inch thick. To improve detectability, a concave groove shall be provided along the centerline of the length. Tactile guidestrips shall be formed with structural flanges, which shall extend below the surface a minimum of 1-1/4 inch.

Section 5.7: Accessible Pedestrian Signal Standards

7.1 Scope: Each crosswalk with pedestrian signal indication shall have a signal device that includes accessible indications of the walk interval. Where a pedestrian pushbutton is provided, it shall be integrated into the signal device and shall comply with the requirements of this section.

7.2 Types and Location of Accessible Pedestrian Signals:

Accessible pedestrian signals (APS) may be either of the following types: (1) Overhead - the APS is mounted to the Pedestrian Head, or (2) Pedestrian Activated Signal Control (PASC) - the APS accessibility features is incorporated into the PASC.

All overhead and PASC accessible pedestrian signal devices shall serve the nearest crosswalk in relationship to their installation site. The speakers of all overhead and PASC APS devices shall be oriented toward the center of the crosswalk or the direction of travel to the maximum extent feasible. If possible due to intersection configuration, all overhead and PASC APS devices shall be separated a minimum of 120 inches from any other APS device, unless on an island or median, where space will not permit.

7.3 Audible Walk Indication:

The audible pedestrian signals shall emit two distinct audible signals that resemble birdcalls; "cuckoo" for the north-south walk phase and "peep-peep" for the east-west walk phase, (per the California Department of Transportation Traffic Manual, Revised, July 1996, Section 9-04.8) or the closest proximity to these compass directions.

Volume measured at 36 inches from the pedestrian signal device shall be between two and five decibel (dB) above ambient noise level and responsive to ambient noise level change. Automatic volume adjustment in response to ambient traffic sound level should be provided up to a maximum volume of 89 dB.

When accessible pedestrian signals have an audible tone, they shall have a tone for the walk interval. The audible tone shall be audible from the beginning of the associated walk interval.

Activation of the pedestrian-activated signal control shall simultaneously activate the accessible pedestrian signal. There shall be no extended button press required to activate the auditory tone feature that announces the onset of the walk interval. An extended button press shall be permitted to activate additional features (e.g. auditory announcement, "wait," "street name," etc). Buttons that provide additional features shall be marked with three Braille dots forming an equilateral triangle in the center of the pushbutton.

7.4 Pedestrian Pushbuttons: Pedestrian pushbuttons shall comply with the details described in this section.

7.4.1 Location: Pedestrian pushbuttons shall be located 60 inches maximum from the crosswalk line extended, and if possible due to intersection configuration, 120 inches maximum and 30 inches minimum from the curb line, and 120 inches minimum from any other pedestrian pushbutton at a crossing. The control face of the pushbutton shall be installed to face the intersection and be parallel to the direction of the crosswalk it serves.

7.4.2 Reach and Clear Space: A clear space measuring 30 inches wide by 48 inches deep shall be provided at each pushbutton and shall connect to or overlap the pedestrian path of travel.

7.4.3 Mounting Height: Pedestrian pushbuttons shall be mounted at a height from 34 inches minimum to 46 inches maximum to the centerline above the lowest adjacent walking surface.

7.4.4 Operation: Pedestrian pushbuttons shall require no more than five pounds of pressure to operate.

7.4.5 Size and Contrast: Pedestrian pushbuttons shall be a minimum of two inches across in one dimension and shall contrast visually with their housing or mounting.

7.4.6 Locator Tone: If used by the particular accessible signal manufacturer, pedestrian pushbuttons shall incorporate a locator tone (one per pole) at the pushbutton. Locator tone volume measured at 36 inches from the pushbutton shall be two dB minimum and five dB maximum above ambient noise level and shall be responsive to ambient noise level changes. Automatic volume adjustment in response to ambient traffic sound level should be provided up to a maximum volume of 89 dB. The duration of the locator tone shall be 0.15 seconds maximum and shall repeat at intervals of one second. The locator tone shall be deactivated when the pedestrian signal system is not operative.

7.4.6.1 Exception: At existing pedestrian pushbuttons without locator tones, pole-supported pedestrian pushbuttons shall be identified with color coding consisting of a textured horizontal yellow band two inches in width encircling the pole, and a one-inch wide dark border band above and below the yellow band. Color-coding should be placed immediately above the pushbutton.

7.4.7 Vibrotactile Indicator: If used by the particular accessible signal manufacturer, pedestrian pushbuttons shall incorporate a vibrotactile indicator at the pushbutton. The vibrotactile indicator shall indicate that the walk interval is in effect, and for which direction it applies, through the use of a vibrating directional arrow. The vibrotactile indicator shall be part of the pedestrian pushbutton and adjacent to the intended crosswalk.

7.5 Directional Information and Signs: If used by the particular accessible signal manufacturer, pedestrian pushbuttons shall provide tactile and visual signs on the face of the device or its housing or mounting indicating crosswalk direction and the name of the street containing the crosswalk served by the pedestrian signal.

7.5.1 Arrow: Signs shall include a tactile arrow aligned parallel to the crosswalk direction. The arrow shall be raised 1/32-inch minimum and shall be 1-1/2 inches minimum in length. The arrowhead shall be open at 45 degrees to the shaft and shall be 33 percent of the length of the shaft. Stroke width shall be 10 percent minimum and 15 percent maximum of arrow length. The arrow shall contrast with the background, white on black or black on white.

7.5.2 Street Name: Signs shall include street name information aligned parallel to the crosswalk direction. The street name shall be printed in non-serif raised white letters a minimum of 5/8 inches high, accompanied by contracted Grade 2 Braille below, on a black background.

Section 5.8: Transportation and Vehicle Access Standards

8.1 Scope: Where new public transportation facilities are constructed or substantially altered within the City-regulated right-of-way, they shall comply with the requirements of this section.

8.2 Location: Bus stops or other transit stops serving fixed transit routes shall be located on at least one pedestrian access route complying with the requirements of Section 5.3 for the pedestrian path of travel from the transit stop to the nearest four-way street intersection. Curb ramps located at the nearest four-way intersection or other locations along the pedestrian access route shall comply with the requirements of Section 5.4.

8.3 Clear Width: The sidewalk adjacent to each transit stop shall provide a minimum clear width of 72 inches, not including the width of any curb that may be present between the sidewalk and the street or gutter, for a minimum length of 28 feet.

8.3.1 Exception: All transit stops directly in front of all school properties shall have a clear width of 96 inches, except frontages in front of fenced play areas with no access may have a clear width of 72 inches.

8.4 Cross Slope: The cross slope of the sidewalk along the required length of the transit stop shall be 1:67 (1.5 percent), with allowances for construction a variance of 1:200 (0.5 percent) in either direction.

8.5 Running Slope: The running slope of the sidewalk along the required length of the transit stop shall not exceed the grade of the adjacent roadway or 1:20 (five percent), whichever is greater.

8.5.1 Advisory: A running slope of no greater than 1:48 (two percent) is preferred.

8.6 Curbs at Streets Adjacent to Sidewalks: Curbs on the street side of the sidewalk along the required length of the transit stop shall be approximately vertical, with a height of at least five inches but no greater than eight inches.

8.7 Surface: The surface of the sidewalk along the required length of the transit stop shall be either Portland cement concrete or asphalt concrete, and it shall be firm, stable and slip-resistant.

8.7.1 Exception: A material other than concrete or asphalt may be used when it can be adequately demonstrated to the ADA Program Access Coordinator that it provides an equal firm, stable, and slip-resistant surface.

8.8 Barrier Curbs at Drop-offs: At transit stops, where a slope behind a sidewalk slopes toward the sidewalk, a barrier curb projecting at least six inches in height above the surface shall be provided to prevent water flow across the sidewalk.

8.9 Bus Shelters: Where Regional Transit provides a shelter at a transit stop, their shelter shall be located along a pedestrian access route complying with Section 5.3, and it shall provide a minimum 42 inches by 60 inches clear space, not including benches that are located completely beneath the shelter.

8.10 Bus Stop Signage: Where provided by Regional Transit, all new bus stop signage shall comply with ADAAG 4.30.2,.3,&.5 (1991).

8.10.1 Exception: Bus schedules, timetables or maps do not have to comply with these standards.

Section 5.9: Street and Sidewalk Furnishings and Appurtenances Standards

9.1 Clear Space: Street and sidewalk furnishings shall have a 30-inch wide (measured parallel to the pedestrian travel direction) by 48-inch deep (measured perpendicular to the pedestrian travel direction) clear space in front of each portion used by a pedestrian and shall be connected to the sidewalk or pedestrian access route.

9.2 Facilities and Elements: Where drinking fountains, telephones, concession stands, kiosks, information counters or public toilet facilities are provided, they shall comply with all applicable portions of the California State Building Code, Chapter 11B.

9.3 Benches: The leading edge of benches and all similar sidewalk furnishings shall be set back 12 inches minimum from the required minimum width of the pedestrian access route. Bench seats shall be 17 inches to 19 inches vertical from the adjacent walkway surface to the seat.

Section 5.10: Temporary Construction Standards

10.1 Scope: Where construction or other temporary conditions prohibit full access to pedestrian facilities with the City-regulated right-of-way, an alternate pedestrian route shall be provided in compliance with the requirements of this section.

10.2 Location: To the maximum extent feasible, the alternate pedestrian route shall parallel the disrupted pedestrian route, on the same side of the street. Where access is not available on the same side of the street, the alternate pedestrian route may be located on the opposite side of the street as long as the distance in excess of the disrupted pedestrian route does not exceed 300 feet, and as long as all requirements of these standards are met.

10.3 Elements: The alternate pedestrian route shall include sidewalks and pedestrian access routes, curb ramps, pedestrian crossings and all other elements included in these standards.

10.4 Width: The alternate pedestrian route shall have a width of 48 inches minimum.

10.4.1 Exception: Where technical infeasibility exists, the alternate pedestrian route may have a width of 36 inches minimum.

10.5 Barricade Protection: The alternate pedestrian route shall be protected with a solid barricade to separate alternate pedestrian route from any adjacent construction, drop-offs, openings or other hazards. Barricades shall be continuous, stable and non-flexible, and shall consist of a solid wall or fence with the bottom or lower rail 1-1/2 inches maximum above the walking surface, and the top of the fence, wall or upper rail 36 inches minimum above the walking surface. Barricade support members shall not protrude beyond the barricade face into the alternate pedestrian route. Barricades shall be of a contrasting color, with yellow or orange preferred.

10.6 Signs: Signs complying with California Building Code Section 1117B.5 shall be provided at both the near side and the far side of the intersection preceding a disrupted pedestrian route, with appropriate wording to guide pedestrians to the alternate pedestrian route. When raised characters or symbols are used, they shall be raised 1/32-inch (0.794 mm) minimum and shall be sans-serif uppercase characters accompanied by Grade 2 Braille. Dots shall be 1/10 inch (2.54 mm) on centers in each cell with 2/10-inch (5.08 mm) space between cells. Dots shall be raised a minimum of 1/40 inch (0.635 mm) above the background.

Section 6: ADA Capital Implementation Plan

Section 6.1: Introduction

The ADA Capital Implementation Plan is a final step in determining the extent of City-operated and other participants' projects necessary to implement the ADA Transition Plan within the City of Rancho Cordova public right-of-way.

Types of projects included can be categorized as follows:

- Curb ramp construction or replacement projects based upon resident request.
- Curb ramp, sidewalk and intersection retrofit projects, included with street overlay or other street or sidewalk construction projects.
- Curb ramp, sidewalk and intersection retrofit projects, in conjunction with construction by private parties.
- Curb ramp, sidewalk and intersection retrofit projects deemed essential for mitigation of barriers based upon the finalized ADA Transition Plan.
- Street and sidewalk construction or retrofit projects planned for the improvement of overall pedestrian facilities.
- Signal retrofit projects.
- Roadway widening projects.

A number of existing and potential programs and funding sources for capital improvement projects are described in this section. These programs include on-going City capital improvement and maintenance programs, as well as specific projects and funding sources allocated in the five year Transportation Improvement Plan (TIP). The ADA Capital Implementation Plan uses, to the maximum extent possible, existing and prospective funding programs and sources. The plan recommends specific goals for the construction of accessibility improvements. While specifying locations and the scope of work, the plan also is intended to serve as a conceptual plan whereby the extent and goals of future projects will be evaluated prior to preparing detailed cost estimates. Once an overall scope of work and its financial impact is established, annual projects can be finalized and the exact number of specified improvements can be set as project goals.

The ADA Capital Implementation Plan includes a detailed and prioritized list of approximately 246 potential project locations and items of work, which have been reviewed by the City of Rancho Cordova, the ADA CAG and the TAC. This implementation plan, which targets higher priority uses, anticipates a 15- to 20-year implementation period to achieve compliance with program accessibility requirements. Additional ADA work, such as new construction and additional curb ramps beyond the minimum program access requirements will continue beyond the timeframe identified above.

Section 6.2: Extent of Required ADA Work

The extent of work included in the ADA Transition Plan includes the types of capital improvements that should be made to intersections, streets and sidewalks. The extent of work included in the plan has been the result of an extensive process that has included review and recommendations of all basic elements of the ADA Transition Plan by the City of Rancho Cordova, the ADA CAG and the TAC. These basic elements include the ADA Codes and Standards, the ADA Monitoring Program and the ADA Prioritized Capital Implementation Plan. The general types and extent of ADA work that is required for the City to transition into compliance with the programmatic access requirements of Title II of the ADA are included in this section.

Most recommended capital improvements will be comprehensive in their approach. A comprehensive approach refers to making a series of related improvements at each particular location of work in an effort to bring the entire location and any public uses (as described in the Use Priority 1 list on a subsequent page), if they occur, into compliance with the applicable ADA Codes and Standards. For example, at a typical four-way signalized intersection, the extent of work would include not only the construction of curb ramps at each corner, but it also would include removing accessibility barriers along the pedestrian route from any Priority 1 use leading to the curb ramps, and installing accessible pedestrian signals, crosswalk striping; accessible islands, if required; and appropriate signage. It is probable that some capital improvement projects may, to a lesser degree, include only specific elements that represent physical barriers that need to be removed at a particular location, or that are specifically funded by an existing program.

The typical extent and scope of work for the most common types of capital improvements, listed from most to least comprehensive, is shown below:

- (1) Complete ADA retrofit of signalized four-way intersection: eight new curb ramps, two per corner (unless infeasible due to existing conditions such as utility conflicts or geometry or an exception as described in Section 5.4); new complying sidewalk paving to meet existing sidewalks and other sidewalk improvements to provide access to Priority 1 uses along the path of travel; new accessible pedestrian signals with push buttons; and crosswalk striping (if not existing, including removal and replacement of crosswalk striping where in poor condition) for all crossing directions where crosswalks are required by the ADA Codes & Standards. Scope may include new islands with cut-throughs or curb ramps, if required by the standards or at the design engineer's discretion.
- (2) Complete ADA retrofit of controlled intersection: eight new curb ramps, two per corner (unless infeasible due to existing conditions such as utility conflicts or geometry or an exception as described in Section 5.4); and crosswalk striping (if not existing, including removal and replacement of crosswalk striping where in poor condition) for all crossing directions where crosswalks are required by the ADA Standards; new complying sidewalk paving to meet existing sidewalks and other sidewalk improvements to provide access to Priority 1 uses along the path of travel. Scope may include providing new

islands with cut-throughs or curb ramps, if required by the standards or at the design engineer's discretion.

- (3) Complete ADA retrofit of signalized T-intersection: six new curb ramps with two per corner, except only one on either side of the top of the T (unless infeasible due to existing conditions such as utility conflicts or geometry or an exception as described in Section 5.4); new accessible pedestrian signals with push buttons; and crosswalk striping (if not existing, including removal and replacement of crosswalk striping where in poor condition) for all crossing directions where crosswalks are required by the ADA Standards; new complying sidewalk paving to meet existing sidewalks and other sidewalk improvements to provide access to Priority 1 uses along the path of travel. Scope may include providing new islands with cut-throughs or curb ramps, if required by the standards or at the design engineer's discretion.
- (4) At signalized intersections, installation of new accessible pedestrian signals with push buttons and crosswalk striping (if not existing, including removal and replacement of crosswalk striping where in poor condition) for all crossing directions where crosswalks are required by the ADA Codes and Standards.
- (5) Partial ADA retrofit at four-way intersection, single-family residential area: four new curb ramps (one per corner); crosswalk striping at all signalized or stop-controlled intersections, for crossing directions where a crossing is not prohibited.
- (6) Partial ADA retrofit at T-intersection, single-family residential area: two new curb ramps to cross main street at one location of T-intersection, and at least one and preferably two new curb ramps to cross secondary street.
- (7) One or more new single curb ramps where other curb ramps at the intersection are complying.
- (8) Renovation of existing curb ramp to remove hazardous conditions.
- (9) Installation of new curb, gutter and concrete sidewalk (Installation of sidewalk should be on a case-by-case basis).
- (10) Partial curb, gutter and sidewalk installation to provide programmatic access (Installation of sidewalk should be on a case-by-case basis).
- (11) Miscellaneous sidewalk or walkway repair or replacement.
- (12) Selected sidewalk and bus pad pavement as required for transit access (Installation of sidewalk should be on a case-by-case basis).
- (13) Selected sidewalk and bus pad pavement as required for new mid-block crosswalk with pedestrian signals (Installation of sidewalk should be on a case-by-case basis).
- (14) Roadway widening or installation of required asphalt conforms for accessible pedestrian access routes.
- (15) Removal of sidewalk barriers (either moving or removing the barrier or reconstructing the pedestrian walkway around the barrier, or the reconstruction of driveways).

Again, the above list is for project planning purposes only, and represents an attempt to categorize the general extent of work at each location. The exact extent of all ADA work is described in the ADA Codes and Standards.

Section 6.3: Prioritization Criteria for ADA Work

Capital improvement projects forming the ADA Capital Implementation Plan have been prioritized to determine which projects should be undertaken first. The major determinants for prioritizing and ranking projects was based upon Sacramento County's "Interim Policy on Streets and Sidewalk Access Improvement Priorities," dated and approved January 16, 2001. It should be noted that the policy regarding prioritization also follows ADA guidelines, as contained in 28 CFR Part 35 section 35.150 (c), (d) and 35.151 (e), and in the Accessibility Policy Statement of the U. S. Department of Transportation, dated July 1999.

Use Priority A: Public Input Requests

The City operates a program of public input requests for constructing curb ramps, installing accessible pedestrian signals and for providing other accessibility improvements on an annual basis. The program is called the "Elderly and Disabled Accessibility Project." Generally, requests for improvements come from community members with disabilities who wish to access shopping areas, medical facilities, bus stops, transportation and other facilities or areas to accommodate their activities of daily living. These requests should continue to be handled as the first line of priority.

When the requests come into the City's ADA Program Access Coordinator, an evaluation for construction or reconstruction is undertaken. If a curb ramp is requested, the evaluation consists of the requested curb ramp and the entire intersection at which the curb ramp is located. Any existing curb ramp is evaluated for usability and safety to determine the usable path of travel through that intersection.

The Elderly and Disabled Accessibility Project primarily replaces curb, gutter and sidewalk sections with curb ramps. These ramps are installed at intersection corners, near schools and hospitals, at driveways or any other curb, gutter and sidewalk where accessibility needs to be improved. The curb ramp need is determined by constituent request, but if insufficient requests are made within the annual funding period, the City recommends additional curb ramps or other improvements necessary to fully use the available funds.

Use Priority 1: State and Local Governmental and Public Use

Priority 1 areas are those within the public right-of-way that abut or serve public and governmental agencies and offices, and include the following in the recommended order of priority:

1. State, county and local government buildings located within the City,
2. Public hospitals, health clinics, medical clinics, mental health clinics and therapy centers,
3. Public housing projects and public homeless shelters,
4. Sheriff neighborhood service centers,
5. CalWorks offices, and Employment Training Agency facilities,
6. City parks,
7. Public schools, including in the following order, but not limited to: community colleges; high school, junior high and elementary school programs with magnet programs for children with disabilities; and all other schools,
8. State and local district offices with high public traffic, beginning with, but not limited to: transportation hubs and major corridors and routes; Department of Motor Vehicles offices; state parks, and prisons.

Use Priority 2: Public Accommodations

Priority 2 areas are those within the public right-of-way that abut or serve places of public accommodations that are privately owned, including, but not limited to, the following in the recommended order of priority:

1. Private hospitals, doctors' offices, and medical and mental health offices,
2. Senior facilities,
3. Major shopping malls,
4. Large housing complexes,
5. Major employment sites,
6. Supermarkets,
7. Retail strip centers,
8. Small apartment facilities,
9. Service sites of disability organizations,
10. Rehabilitation facilities.

Use Priority 3: Low-Density Residential and Other Uses

Priority 3 areas are those within the public right-of-way that abut or serve:

1. Single-family residential areas,
2. Industrial areas,
3. Areas that have not fallen into any of the above groups.

Current City policy also uses basic considerations and evaluation factors when determining whether a curb is suitable for construction or reconstruction. These factors are called condition priorities because they are based on the physical condition of an existing intersection, corner or curb ramp. These factors also are used for consideration when determining the priority within a category/group list. The following list describes these factors, in order of importance:

Condition Priority 1:

The highest priority is to reconstruct curb ramps at locations where existing curb ramps have an unsafe condition that may cause a trip and fall. Examples are vertical displacement of the curb ramp, steep side slopes, deteriorated conditions, etc. (See also discussion of unsafe conditions in Condition Priority 5 below.)

Condition Priority 2:

A new curb ramp will be installed at locations where there is no curb ramp to provide accessibility.

Condition Priority 3:

When a corner has one existing curb ramp and conditions allow for the construction of an additional curb ramp at the same corner, and provided that traffic controls allow for a safe path of travel, an additional curb ramp will be installed. (This condition applies only to corners at intersections on arterial and thoroughfare streets, and that it would not apply to signalized locations on major streets for which the geometry of the intersection makes it impossible to install an eight-phase signal operation.)

Condition Priority 4:

A curb ramp is constructed or reconstructed at a location with difficult physical conditions such as major utility conflicts, physical barriers, or other constraints, which would create a hardship situation on the entity. (At rare locations, existing conflicting facilities or intersection geometry may make installation of a curb ramp technically infeasible.)

Condition Priority 5:

An existing curb ramp will be reconstructed when it does not meet current federal and state accessibility standards (i.e. steep slopes, improper landings, lack of detectable warnings, etc.).

In reviewing the priorities for reconstructing existing curb ramps, the City should establish criteria that separate existing curb ramps that are so bad that they pose a real barrier or safety hazard from those that are just a bit out of specifications. Such determinations should be made on a case-by-case basis as described in Section 3.6. All of these non-complying curb ramps should be on the list of ADA-required work, but those curb ramps that for most persons work fairly well should be shifted to the end of the list. It is recommended that such criteria for those curb ramps and

related facilities that are out of compliance, but not posing a great need for quick reconstruction, are those with one or more of the following:

- Main slopes greater than 8.3 percent, but less than 11 percent.
- Side flared slopes greater than 10 percent, but less than 12 percent.
- Pan or landing cross-slopes greater than two percent, but less than four percent.
- Gutter slopes greater than five percent, but less than ten percent.
- Detectable warning surfaces missing.
- Curb ramp lips greater than one-half inch, but less than one inch.

All of these prioritization criteria were used, although not at the level of filling out evaluation forms for each curb ramp or intersection, in the preparation of the ADA Capital Implementation Plan.

Section 6.4: Pedestrian Advisory Committee

The City of Rancho Cordova will establish a Pedestrian Advisory Committee, which will include representatives with disabilities. The purpose of the committee is to comment on pedestrian and disability access projects when they are in the design phase to ensure that pedestrian and disability access issues are properly considered. The City will recommend and appoint individual members to the committee. The committee members must live or work in the City of Rancho Cordova, and will serve for a maximum of three consecutive years. The committee will meet quarterly to discuss upcoming projects. Committee members also may recommend topics for agenda items. The committee meetings will be staffed with at least one representative from the City.

Section 6.5: Types of Projects and Funding Sources

There are a number of existing and potential programs and funding sources for capital improvement projects included in the ADA Capital Implementation Plan. These programs are described in this section.

On-Going Capital Improvement Programs

These programs are operated by or coordinated with the City on an on-going, annual basis. The extent of funding levels may be fixed or may vary yearly. These programs include the following:

1) Curb, Gutter and Sidewalk Maintenance Program

The City's Curb, Gutter and Sidewalk Maintenance Program identifies curbs, gutters and sidewalks that are in need of repair or replacement and develops a priority list for their inclusion into the maintenance program. The Curb, Gutter and Sidewalk Maintenance Program has two facets: permanent replacement and temporary repair. Priority is based upon such factors as severity of damage, the amount of pedestrian traffic, and the proximity to schools, parks, bus stops and hospitals.

Defective residential curb, gutter and sidewalks are prioritized by a computerized rating system. Areas with sidewalks that have the highest numerical rating are inspected for any additional work that may not have been reported. Defective sidewalks in the immediate neighborhood then are included in the contract for replacement.

Damaged pavement must meet certain criteria to be added to the scheduled priority list. Criteria includes: uplift or sag of 3/4 inch or more, misalignment of 1-1/4 inches or more, or standing water of more than one inch deep for a distance of more than ten feet. These criteria should be revised to comply with current ADA standards.

2) Elderly and Disabled Accessibility Project

The Elderly and Disabled Accessibility Project primarily replaces curb, gutter and sidewalk with new curb ramps. These curb ramps and sidewalks are installed near schools and hospitals, at driveways, or at other curb, gutter and sidewalk locations where accessibility for persons with disabilities could be improved. Accessible pedestrian signals and tactile guidestrips also are installed as part of this program. Improvement needs are determined by constituents' requests. The Elderly and Disabled Accessibility Project is funded by Measure A funds.

3) Pavement Maintenance Program (Street Overlay Projects)

The City operates an annual pavement maintenance program for overlaying streets with new asphalt. Recent federal court judgments (most notably *Kenney v. Yerusalem, PA.*) have required that curb ramps be installed along sidewalks adjacent to street overlays, and the City has and continues to construct numerous curb ramps as a part of these projects.

4) Caltrans Construction Projects

Caltrans construction and renovation of roadways and facilities along State highways within the City typically includes new curb ramps and other accessibility-related improvements. While the City does not directly manage these projects, it coordinates locations and details of the work with Caltrans.

5) Private Developer Construction Projects adjacent to the City Right-of Way

There is typically private construction throughout the City that has direct impact on improvements within the City right-of-way. As a condition of the approval of a building permit, contractors are typically required to construct or improve the sidewalk, including curb ramps, directly adjacent to the subject property. For larger projects, developers also may be required to construct intersections complete with traffic signals.

A renewed training effort for plan checkers and inspectors is recommended to assure that the full potential of the ADA Transition Plan is realized.

Specific Funding Programs and Projects

The ADA Capital Implementation Program is envisioned as one that will use, to the maximum extent possible, existing and prospective funding programs and sources. The ADA improvements will be funded by a variety of funding sources either as stand alone projects or as a minor component of a transportation improvement project. These programs and sources include the following:

1) Funding Programs

Measure A Sales Tax Program: The Measure A Sales Tax Program uses Measure A revenues and expenditures for specific projects from FY (Fiscal Year, from July 1 - June 30) 2001/2002 through FY 2006/2007.

Development Fee Program: The Development Fee Program uses fees charged to developers of large housing and commercial projects and has allocations for FY 2001/2002 through FY 2006/2007.

Financing Districts: Expenditures and funding allocations are planned for the various City of Rancho Cordova Financing Districts including:

- Developer Fee
- Mather Field
- SunRidge
- Villages of Zinfandel

State Funding Programs: projects funded by the various State funding programs:

STIP- State Transportation Improvement Program

SR2S- Safe Routes to School Program

TCRP- Traffic Congestion Relief Program

Federal Funding (ISTEA): Funding approved under the Intermodal Surface Transportation Efficiency Act of 1991 (ISTEA) programs:

CMAQ- Congestion Mitigation and Air Quality Program

HBRR- Highway Bridge Replacement & Rehabilitation Program

HES- Hazard Elimination & Safety Program

RSTP- Regional Surface Transportation Program

TEA- Transportation Enhancement Activities

Federal Funding (TEA-21): Funding approved under the 1998 Transportation Equity Act for the 21st Century (TEA-21). The funding programs included in TEA-21 are the same as for ISTEA, as indicated above. The CIP also includes funding allocations from

the TEA-21 Intelligent Transportation Systems (ITS) Program for the Watt Avenue Transit Priority and Mobility Enhancement project.

2) Specific City Construction Projects

The following specific projects are funded through FY 2006-2007. The list does not include all City projects, but those that provide for a significant degree of funding for necessary accessibility improvements. Other projects also may be included in the detailed project list that follows in Appendix C.

- Coloma Rd. Enhancements, Sunrise Blvd. to West of Truckee Rd.
- Folsom Blvd. Enhancements Project: Rod Beaudry Dr. to Sunrise Blvd.
- Mather Field Road Enhancements: Folsom Blvd. to Peter McCuen Blvd.
- Sunrise Blvd. Landscaping, Gold Country Blvd. to Zinfandel Dr.
- Mather Field Road at U.S. 50 Interstate Landscaping

3) ADA Transition Plan Funding

As part of the ADA Transition Plan, it is foreseen that an ADA Transition Plan Retrofit Project will be recommended to provide funding for required ADA improvements. Funding may come from one or more of either Measure A sales tax funds, developer fees, Sacramento Area Council of Government programs, and currently unspecified sources, and not necessarily from City funds.

Section 6.6: Description of ADA Capital Implementation Plan

The ADA Capital Implementation Plan of the ADA Transition Plan includes specified goals for the construction of accessibility improvements. The exact goals should take into account all of the various items of work required under the plan, including curb ramps, accessible pedestrian signals, sidewalk barrier removal and sidewalk installation, crosswalk markings and other work necessary to comply with the ADA Codes and Standards. The ADA Capital Implementation Plan lays the groundwork for concepts concerning the extent of ADA work required, prioritization, locations and potential funding sources. Until exact funding sources are finalized, the annual work and expenditures proposed must be of a preliminary nature.

It is recommended that the City commit to an aggressive schedule to bring Rancho Cordova into ADA compliance. This work should include installation, repair and replacement of curb ramps, together with other specified improvements, on an annual basis. An evaluation of existing annual ADA work is presented on the following page as Table 3.

The Elderly and Disabled Program annual funding will be used to implement the highest priority locations of the ADA Capital Implementation Plan. In addition, the existing funding sources will continue to fund locations within the plan. The above table assumes that sidewalk repair will include the items described in Section 6.4 as part of the Curb, Gutter and Sidewalk Maintenance Program, plus the removal of other barriers that may be subsequently determined as part of the ADA. Likewise, sidewalk repair work would include the retrofit of existing driveways that have excessive cross slope, by using methods presented in the Pedestrian Design Guidelines and other criteria to be subsequently determined as part of the ADA. The pedestrian bridges identified in Section 4.5, as well as other similar examples, also are included in the recommended list of improvement projects that should be upgraded as part of this ADA Transition Plan.

Section 6.7: Detailed Reports of Proposed Work

Detailed descriptions of proposed disabled access improvement projects are included in the Sidewalk and Intersection Database, as described in Section 4.6. A table of CIP projects is included in Appendix C and a summary of the projects per year is shown in Table 3. The City plans to allocate approximately \$100,000 annually to implement the ADA Transition Plan, and also plans to apply for competitive funds to accelerate the transition process. For most of the fiscal year allocations, the total is less than \$100,000 to allow for expenditures on projects that originate through community member requests using the grievance procedure mentioned in the next section.

The ADA improvement projects are subdivided by fiscal year as part of a 15 to 20 year implementation plan. It is estimated that this period would yield a degree of compliance that could be described as compliance with Use Priorities 1 and 2 and Condition Priorities 1 and 2, as described in Section 6.3. It is felt that a detailed breakdown of projects past these periods would be inappropriate, since conditions would be subject to numerous changes over such a time span. It is anticipated that overall compliance with all Use and Condition Priorities could be achieved in 25 to 30 years.

The locations of work are subject to review and recommendations by the City, the ADA Transition Plan Oversight Committee, the Pedestrian Advisory Committee and the public. Likewise, it is probable that specific locations and project groupings will need to be adjusted among the various years of the plan, after a more detailed review by the City's program managers. Other breakdowns of proposed work locations and extent are available, including by types of work or funding sources. It should be noted that the detailed field surveys undertaken, as described in Section 4, form the basis of existing conditions requiring correction under the proposed projects. It should also be noted that the detailed reports include projects that may be part of the ADA Transition Plan work implemented and funded by other jurisdictions or municipalities.

Construction and soft costs given in both the detailed and summary tables of improvement projects should be considered schematic, order of magnitude costs, based upon the unit costs and estimating parameters developed specifically for this ADA Transition Plan. The costs include all incidental soft costs, such as engineering, bidding and permitting costs, utilities and other appurtenances and contingencies.

The detailed table of improvement projects does not necessarily depict the complete and exact locations of all sidewalk and driveway repair work to be undertaken as part of the ADA Transition Plan, since much of this work will be determined by public input requests and will be evaluated in conjunction with intersection work or other construction projects. It should be noted that the Pedestrian Master Plan Draft Capital Improvement Program also contains sidewalk and related pedestrian access work.

Figure 9 represents a graphic depiction of the various locations of improvements included in the ADA Capital Implementation Plan.

Table 3: Summary of ADA Implementation Plan Projects by Fiscal Year

Fiscal Year	Inter- sections	Est. Curb Ramp Costs	Est. Accessible Signal Costs	Est. Cross- walk Costs	Est. Sidewalk Costs	Est. Cap. Improve- ment Costs
05/06	17	\$78,165	\$0	\$9,120	\$12,710	\$99,995
06/07	2	\$62,600	\$0	\$10,640	\$12,300	\$85,540
07/08	19	\$513,320	\$88,800	\$50,920	\$63,970	\$717,010 ¹
08/09	3	\$75,120	\$0	\$12,160	\$14,050	\$101,330
09/10	2	\$62,600	\$0	\$7,600	\$18,450	\$88,650
10/11	2	\$62,600	\$0	\$7,600	\$12,710	\$82,910
11/12	1	\$50,080	\$11,840	\$6,080	\$12,300	\$80,300
12/13	3	\$75,120	\$0	\$9,120	\$19,680	\$103,920
13/14	3	\$75,120	\$0	\$9,120	\$19,680	\$103,920
14/15	2	\$75,120	\$0	\$9,120	\$8,310	\$92,550
15/16	2	\$75,120	\$0	\$9,120	\$8,310	\$92,550
16/17	3	\$75,120	\$0	\$9,120	\$19,270	\$103,510
17/18	2	\$75,120	\$0	\$9,120	\$12,300	\$96,540
18/19	3	\$75,120	\$0	\$9,120	\$20,500	\$104,740
19/20	2	\$75,120	\$0	\$9,120	\$8,310	\$92,550
20/21	3	\$75,120	\$0	\$9,120	\$19,270	\$103,510
21/22	2	\$75,120	\$0	\$9,120	\$13,120	\$97,360
22/23	3	\$75,120	\$0	\$9,120	\$19,270	\$103,510
23/24	2	\$50,080	\$0	\$6,080	\$12,710	\$68,870
24/25	2	\$75,120	\$0	\$9,120	\$16,400	\$100,640
Remaining	101	\$2,370,560	\$44,400	\$267,520	\$687,390	\$3,369,870
20-Yr Total	78	\$1,856,005	\$100,640	\$219,640	\$343,620	\$2,519,905
All Projects	179	\$4,226,565	\$145,040	\$487,160	\$1,031,010	\$5,889,775

¹ Funding for these projects comes from the Folsom Blvd. Enhancement Project.

Note: Costs included in this table do not include community member request projects.

Figure 9: ADA Projects by Fiscal Year

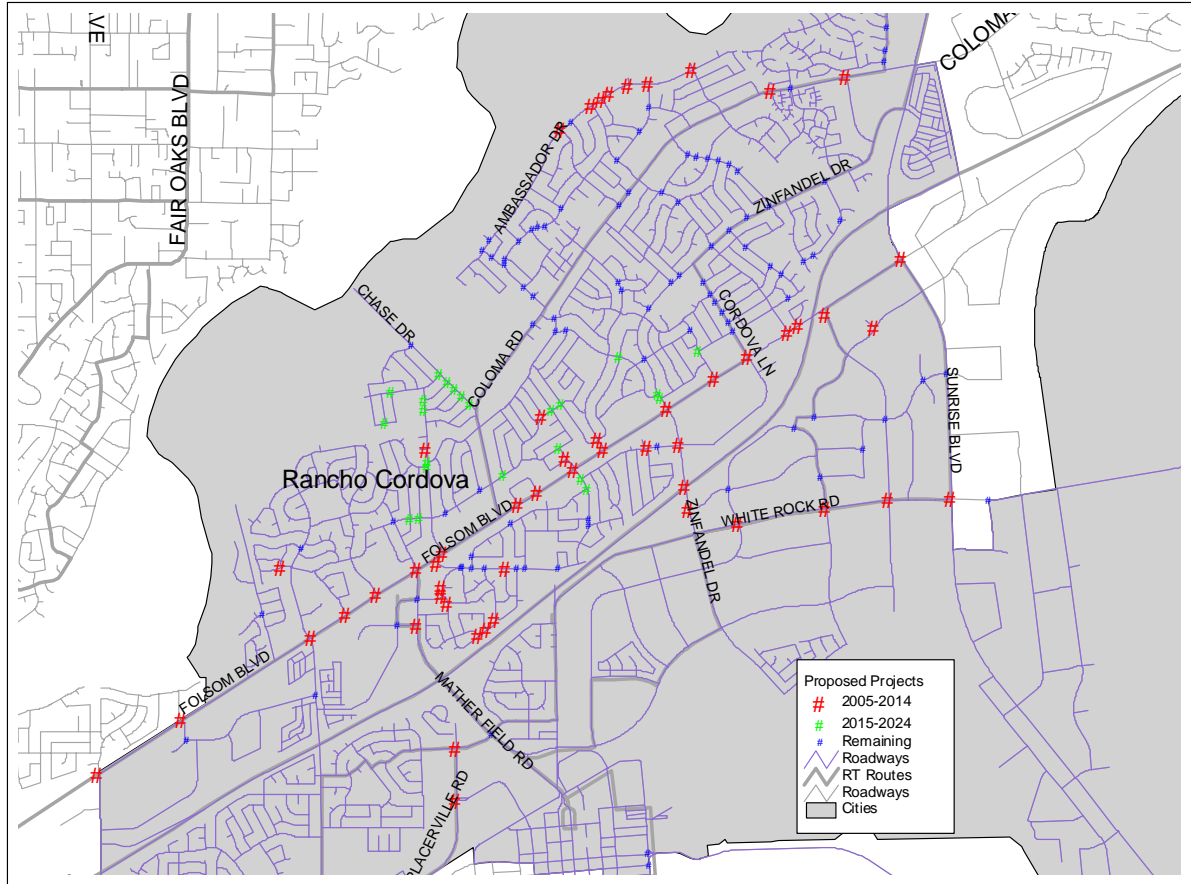

Section 7: Monitoring and Status Reporting

Section 7.1: Introduction

The City currently is engaged in an on-going effort to construct curb ramps, sidewalks, and other pedestrian facilities at numerous locations. This construction activity involves several types of projects, including street overlay projects, street beautification projects, utility construction projects and other capital improvement projects in the public right-of-way. In addition, when this ADA Transition Plan is approved and implemented, more curb ramps and related improvements will be constructed.

While it is important to assure that codes and standards used to design and construct curb ramps and related improvements are up-to-date, it is equally important that ADA improvements are constructed properly and in compliance with all applicable codes and standards. Therefore, the monitoring of construction activities and the reporting of the status of improvements is vital in assuring an effective overall compliance program.

This section details the methods and procedures for monitoring these construction activities and for tracking the status of compliance with the ADA Transition Plan for the public right-of-way at all construction locations within the City.

Section 7.2: Field Inspections and Monitoring

All curb ramps and sidewalks currently being constructed under the jurisdiction of the City are required to be personally inspected by a trained inspector either employed by or under contract with the City. The types of projects under which curbs ramps and other improvements are or will be constructed and inspected are the following:

1. Curb ramp or sidewalk construction or rehabilitation undertaken under the jurisdiction of the City or its contractors as part of capital improvement projects or other specialized construction projects,
2. Curb ramp or sidewalk construction or rehabilitation undertaken by other agencies or private parties within the City, over which the City has jurisdiction, and
3. Curb ramp or, sidewalk construction or rehabilitation undertaken as part of the ADA Transition Plan.

Specific procedures for all field inspections are recommended to be as follows:

1. Every curb ramp constructed under the jurisdiction of the City is to be personally inspected by a Department-approved inspector within ten days after the completion of the curb ramp construction. All inspectors are to be appropriately trained to know and understand the ADA Codes and Standards, as described in Section 5, and the measurements necessary to inspect curb ramps and other improvements as they are constructed.
2. The inspector is to inspect and obtain all dimensions using a tape measure to verify that all dimensions meet or exceed the ADA Codes and Standards.
3. The inspector is to inspect and obtain all slopes and gradients using a two-foot to four-foot long Smart-level or equal slope-measurement tool to verify that all slopes and gradients meet or exceed the ADA Codes and Standards. Three measurements are to be taken and recorded for each access-related slope.
4. The inspector is to inspect all other physical conditions relating to the curb ramp and related construction to verify that all construction meets or exceeds the ADA Codes and Standards.
5. The inspector is to inspect all physical conditions relating to the installation of all accessible pedestrian signals to verify that all installations meet or exceed the ADA Codes and Standards.
6. The inspector is to inspect all physical conditions relating to the installation of all sidewalks to verify that all installations meet or exceed the ADA Codes and Standards.
7. All dimensions, slopes, and other conditions verified in 2, 3, 4, 5, and 6 above are to be entered on approved Curb Ramp Inspection Forms, Pedestrian Signal Inspection Forms, and Sidewalk Inspection Forms, and such forms are to be certified as correct and truthful by the Inspector's signature.
8. Any exceptions to full compliance with the ADA Codes and Standards are to be described on the Curb Ramp Inspection Form, Pedestrian Signal Inspection Form or Sidewalk Inspection Form, certified as a "Finding for Non-compliance Element(s)" by the inspector, reviewed and approved by the Program Manager, and finally approved

by the City Engineer or his/her authorized representative and the ADA Program Access Coordinator or his/her authorized representative.

9. The Curb Ramp Inspection Form, Pedestrian Signal Inspection Form and Sidewalk Inspection Form are to be submitted to the ADA Program Access Coordinator within ten days after the completion of the curb ramp construction.

Copies of the Curb Ramp Inspection Form, the Pedestrian Signal Inspection Form and the Sidewalk Inspection Form are included in a following section.

Section 7.3: Computerized Tracking and Status Reporting

Once the Curb Ramp Inspection Form, Pedestrian Signal Inspection Form, and Sidewalk Inspection Form have been completed and approved for each constructed curb ramp, installed pedestrian signal or constructed sidewalk, the data are to be entered into the master Sidewalk and Intersection Database. This database has been developed as part of the overall ADA Transition Plan project, and it contains detailed data for intersections, sidewalks and roadways throughout the City.

The data entry for the Curb Ramp Inspection Forms, Pedestrian Signal Inspection Forms and Sidewalk Inspection Forms could be performed either by the field inspectors themselves or by separate clerical personnel, at the discretion of the Program Manager.

The computerized database is intended to be made available to the general public, either by public access computers made available at the Public Works Department office or other methods to be determined by the City. In addition, City staff will be available to the general public to provide updated monitoring and status reports upon request.

Section 7.4: Sample Curb Ramp Survey / Status Report

Date of inspection 1/2/03
 Project CRP-2003-2
 Contractor Curb Ramp Const. Co.
 City Inspector Joe Curbramp

Intersection (GIS) number: 1800
 North/south street: Opal St
 East/west street: Johnson Ave.
 Corner position: NE
 Curb ramp type: Pan
 Orientation: Center
 Street facing curb ramp: Intersection
 Curb type: Vertical
 Adjoining sidewalk present: Yes
 Marked crosswalk present: Yes
 Intersection priority: 1

<u>Curb Ramp Conditions</u>	<u>Requirement</u> <u>(Acceptable Range)</u>	<u>Measurement</u>	<u>Complies</u>
Gutter/street slope:	2.0% to 5.0%	4.7%	Yes
Pan slope:	1.5% to 2.0%	1.8%	Yes
Left side slope:	2.0% to 8.33%	8.2%	Yes
Left transition slope:	2.0% to 5.0%	4.2%	Yes
Right side slope:	2.0% to 8.33%	4.7%	Yes
Right transition slope:	2.0% to 5.0%	6.2%	No
Width of pan:	48 inches or greater	51 inches	Yes
Width of curb ramps:	48 inches or greater	50 inches	Yes
Lip at street:	None (0 inches)	None	Yes
Curb installed behind pan:	Yes	Yes	Yes
Common landing between ramps:	---	None	N.A.
Common landing length:	N.A.	N.A.	N.A.
Grooved border installed:	Yes	Yes	Yes
Detectable warnings installed:	Yes	Yes	Yes
Curb ramp within marked crosswalk:	Yes	Yes	Yes

<u>Pedestrian Signal Conditions</u>	<u>Requirement</u> <u>(Acceptable Range)</u>	<u>Measurement</u>	<u>Complies</u>
Push button within 60 inches of crosswalk:	Yes	Yes	Yes
Push button height:	36 to 46 inches	42 inches	Yes
Push button diameter:	2 inches	2 inches	Yes
Clear space 30 inches by 48 inches minimum:	Yes	Yes	Yes
Push button parallel to crosswalk:	Yes	Yes	Yes
Accessible pedestrian signal operational:	Yes	Yes	Yes
Locator tone operational:	Yes	Yes	Yes

Other Comments: None

Section 7.5: Inspection Forms

Copies of the Curb Ramp Inspection Form, the Pedestrian Signal Inspection Form and the Sidewalk Inspection Form are included on the following pages.



Curb Ramp Inspection Form

Must be filled out for every ramp constructed in City right-of-way in the City of Rancho Cordova. This form must be filled out and submitted within ten days of ramp construction to the ADA Program Access Coordinator.

Curb Ramp Location:

N/E N/W S/E S/W

N/S STREET _____

E/W STREET _____

Project Name: _____

Curb Ramps per City Standard Drawing 4-23 & 4-24:

Vertical Curb Rolled curb

Check One:

One Ramp Two Ramps

STANDARDS:

- NO POLES OR PULLBOXES SHALL BE LOCATED IN RAMPS
- ALL ELEMENTS, EXCEPT GUTTERS AND RETAINING CURBS, MUST BE CONSTRUCTED PLANAR IN NATURE, WITH WEAKENED PLANED JOINTS SCORED BETWEEN EACH ELEMENT.
- PAN MUST BE WITHIN STRIPED CROSSWALKS

A1: _____ B1: _____ C1: _____ D1: _____

A2: _____ B2: _____ C2: _____ D2: _____

A3: _____ B3: _____ C3: _____ D3: _____

RIGHT SIDE LENGTH: _____ FT. _____ IN.

PAN WIDTH: _____ FT. _____ IN.

LEFT SIDE LENGTH: _____ FT. _____ IN.

IF TWO RAMPS ON CORNER (DATA FOR 2ND RAMP):

E1: _____ F1: _____ G1: _____ H1: _____

E2: _____ F2: _____ G2: _____ H2: _____

E3: _____ F3: _____ G3: _____ H3: _____

RIGHT SIDE LENGTH: _____ FT. _____ IN.

PAN WIDTH: _____ FT. _____ IN.

LEFT SIDE LENGTH: _____ FT. _____ IN.

DISTANCE BETW. RAMPS: _____ FT. _____ IN.

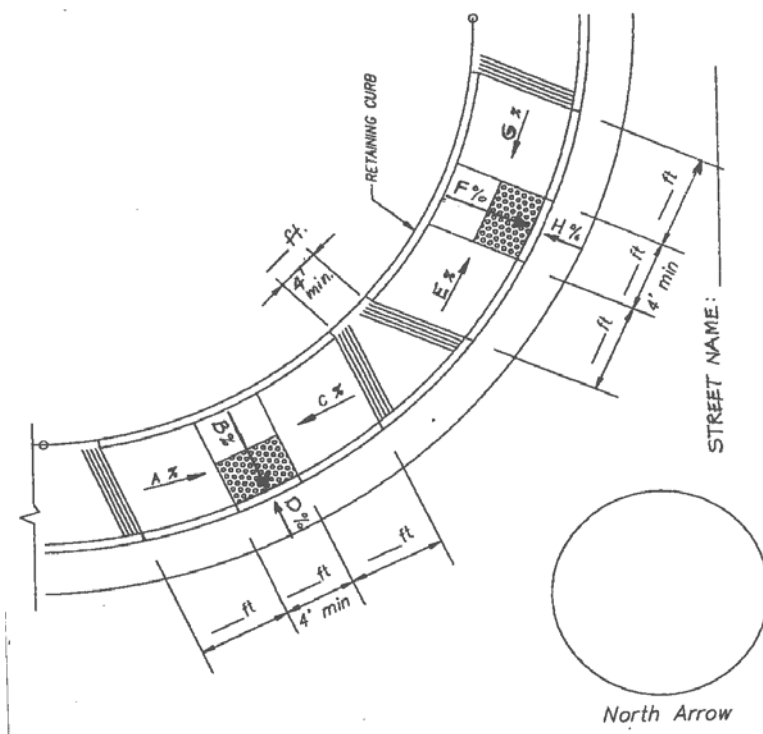

STREET NAME: _____

Inspected/measured by (print): _____ Date Field Measured: _____

Directions:

Three measurements for all data shall be taken at the ramps and pans, one measurement shall be taken at the centerline of the element and the other two shall be taken 18 inches on either side of the first measurement for the element. None of the three recorded measurements of any element may exceed the limits indicated above.

See reverse side for Compliance with Standards.

Curb Ramp Inspection Form

Compliance with Standards:

Note: All curb ramps should comply with the City’s current design and construction standards. Where it is infeasible to construct or reconstruct a curb ramp to current standards, the Designer or Inspector must complete the Findings for Non-compliance Element(s) section below and state what the non-compliant element(s) are and the reason for the non-compliance. A drawing or picture can be included in the box below. After completing this form submit it to the ADA Program Access Coordinator for acceptance and then signature by the City Engineer.

Findings for Non-Compliance Element(s): _____

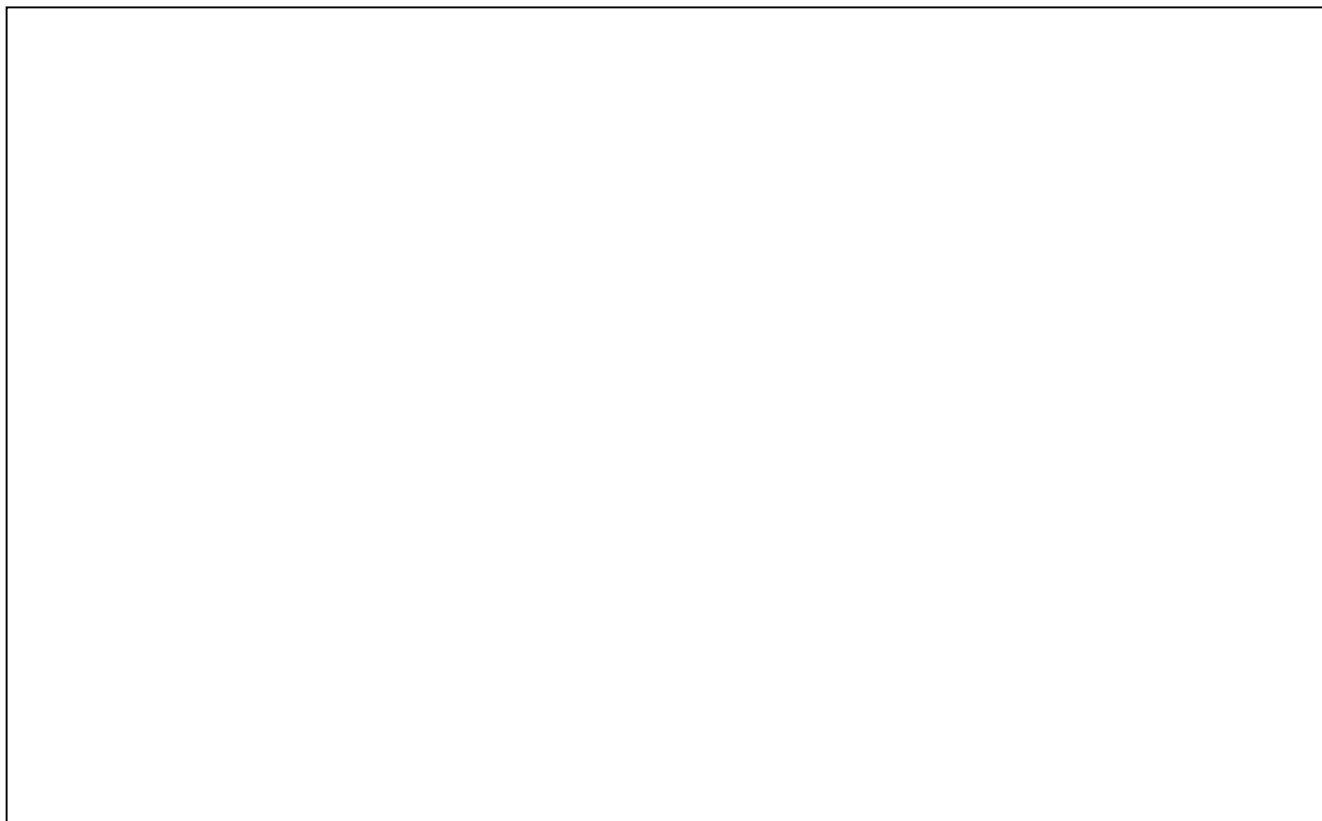

Picture or Drawing, if needed

Designer/Inspector Date

Reviewed by Date
Program Access Coordinator

Approved by City Engineer Date

Signature

Signature

Signature



Pedestrian Signal Inspection Form

Must be filled out for all new pedestrian signals installed in City right-of-way. This form must be filled out and submitted within ten days of signal installation to the City ADA Program Access Coordinator.

Pedestrian Signal Location:

Project Name: _____

N/E N/W S/E S/W

N/S STREET _____

E/W STREET _____

Pedestrian Signals per City Standard Drawings:

Check One:

Vertical Curb Rolled curb One Ramp Two Ramps

STANDARDS:

- EACH PUSH BUTTON LOCATED WITHIN 60" OF EXTENDED CROSSWALK LINE, AND 120" FROM OTHER BUTTONS.
- EACH PUSH BUTTON LOCATED 120" MAX. AND 30" MIN. FROM CURB LINE.
- PUSH BUTTON PARALLEL TO DIRECTION OF CROSSING.
- CLEAR SURFACE SPACE OF 30" X 48" AT PUSH BUTTON.
- HEIGHT TO C.L. OF PUSH BUTTON FROM 42" TO 46" MAX.
- MAX. 5 LBS. OF PRESSURE TO OPERATE.
- LOCATOR TONE FROM 2 DB TO 5 DB, & ABOVE AMBIENT.

IF ONE PUSH BUTTON IS PRESENT:

A:

HEIGHT OF PUSH BUTTON (IN.): _____
 DIAMETER OF PUSH BUTTON (IN.): _____
 ACCESSIBLE SIGNAL OPERATIONAL (Y/N): _____
 LOCATOR TONE OPERATIONAL (Y/N): _____
 PUSH BUTTON PARALLEL TO DIRECTION (Y/N): _____

IF TWO PUSH BUTTONS ARE PRESENT:

B:

HEIGHT OF PUSH BUTTON (IN.): _____
 DIAMETER OF PUSH BUTTON (IN.): _____
 ACCESSIBLE SIGNAL OPERATIONAL (Y/N): _____
 LOCATOR TONE OPERATIONAL (Y/N): _____
 PUSH BUTTON PARALLEL TO DIRECTION (Y/N): _____

ANY CONDITIONS NOT IN COMPLIANCE WITH THE STANDARDS LISTED ABOVE _____

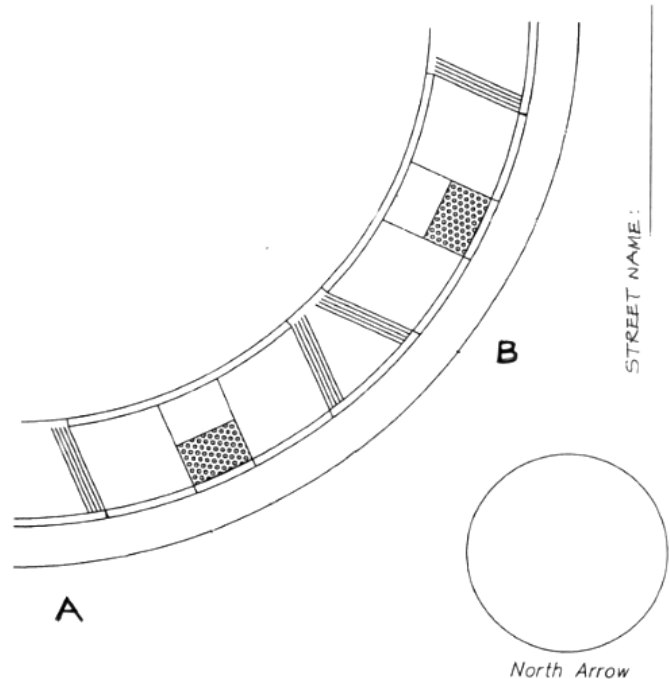

STREET NAME: _____

DRAW LOCATION OF PUSH BUTTON(S) AT THE PROPER LOCATION (IF ONLY ONE RAMP, DRAW BUTTON LOCATION ON RAMP A)

Inspected/measured by (print): _____ **Date Field Measured:** _____

See reverse side for Compliance with Standards.

Pedestrian Signal Inspection Form

Compliance with Standards:

Note: All pedestrian signals should comply with the City's current design and construction standards. Where it is infeasible to install pedestrian signals to current standards, the Designer or Inspector must complete the Findings for Non-compliance Element(s) section below and state what the non-compliant element(s) are and the reason for the non-compliance. A drawing or picture can be included in the box below. After completing this form, submit it to the City ADA Program Access Coordinator for acceptance and then signature by the City Engineer.

Findings for Non-Compliance Element(s): _____

Picture or Drawing, if needed

Designer/Inspector Date

Reviewed by Date
Coordinator

Approved by City Engineer Date

Signature

Signature

Signature



Sidewalk Inspection Form

Must be filled out for every sidewalk constructed in City right-of-way in the City of Rancho Cordova. This form must be filled out and submitted within ten days of construction to the ADA Program Access Coordinator.

Street: _____ **Project Name:** _____

Sides of Street:

N E S W

Nearest Cross-Streets:

STREET _____ STREET _____

Sidewalks per City Standard Drawing 4-25:

Vertical Curb Rolled curb No Curb

Check all that apply:

Planter strip entire length Partial length planter strip

STANDARDS:

- CLEAR WIDTH AT LEAST 48" (NOT INCLUDING CURB) OR AT LEAST 36" AT AN OBSTRUCTION
- NO OVERHEAD OBSTRUCTIONS LOWER THAN 84".
- CROSS-SLOPE 1.5%. RUNNING SLOPE NOT GREATER THAN STREET OR 5%, WHICHEVER IS GREATER.
- NO GAPS WIDER THAN 1/2".
- SURFACE CONCRETE OR ASPHALT, BROOM FINISH OR EQUAL SLIP-RESISTANCE.
- NO DROP-OFF GREATER THAN 4" AT BACK OR AT PLANTER STRIP.

NORTH OR EAST CROSS-STREET _____

NORTH OR WEST SIDE OF STREET:

SIDEWALK CLEAR WIDTH: A1: _____ FT. _____ IN.
 A2: _____ FT. _____ IN.
 A3: _____ FT. _____ IN.

PLANTER STRIP WIDTH: B: _____ FT. _____ IN.
 (PUT "0" IF NO PLANTER STRIP)

RUNNING SLOPE: C1: _____ % C2: _____ % C3: _____ %

CROSS-SLOPE: D1: _____ % D2: _____ % D3: _____ %

OTHER SPECIFIC CONDITIONS: _____

SOUTH OR EAST SIDE OF STREET:

SIDEWALK CLEAR WIDTH: E1: _____ FT. _____ IN.
 E2: _____ FT. _____ IN.
 E3: _____ FT. _____ IN.

PLANTER STRIP WIDTH: F: _____ FT. _____ IN.
 (PUT "0" IF NO PLANTER STRIP)

RUNNING SLOPE: G1: _____ % G2: _____ % G3: _____ %

CROSS-SLOPE: H1: _____ % H2: _____ % H3: _____ %

OTHER SPECIFIC CONDITIONS: _____

DRAW ALL OBSTRUCTIONS OR HAZARDS ON THE PLAN:

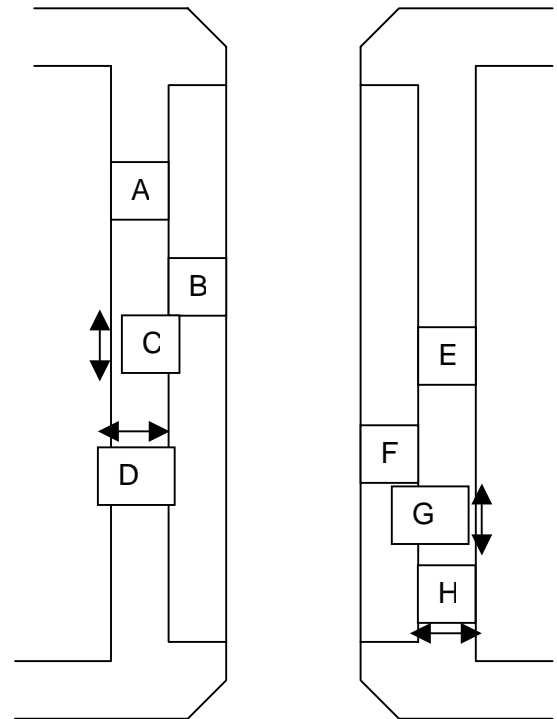

SOUTH OR EAST CROSS-STREET _____

Inspected/measured by (print): _____ **Date Field Measured:** _____

Directions: Three measurements shall be taken at various locations along the sidewalk. None of the three recorded measurements may exceed the limits indicated above. See reverse side for Compliance with Standards.

Sidewalk Inspection Form

Compliance with Standards:

Note: All sidewalks should comply with the City's current design and construction standards. Where it is infeasible to construct or reconstruct a sidewalk to current standards, the Designer or Inspector must complete the Findings for Non-compliance Element(s) section below and state what the non-compliant element(s) are and the reason for the non-compliance. A drawing or picture can be included in the box below. After completing this form, submit it to the ADA Program Access Coordinator for acceptance and then signature by the City Engineer.

Findings for Non-Compliance Element(s): _____

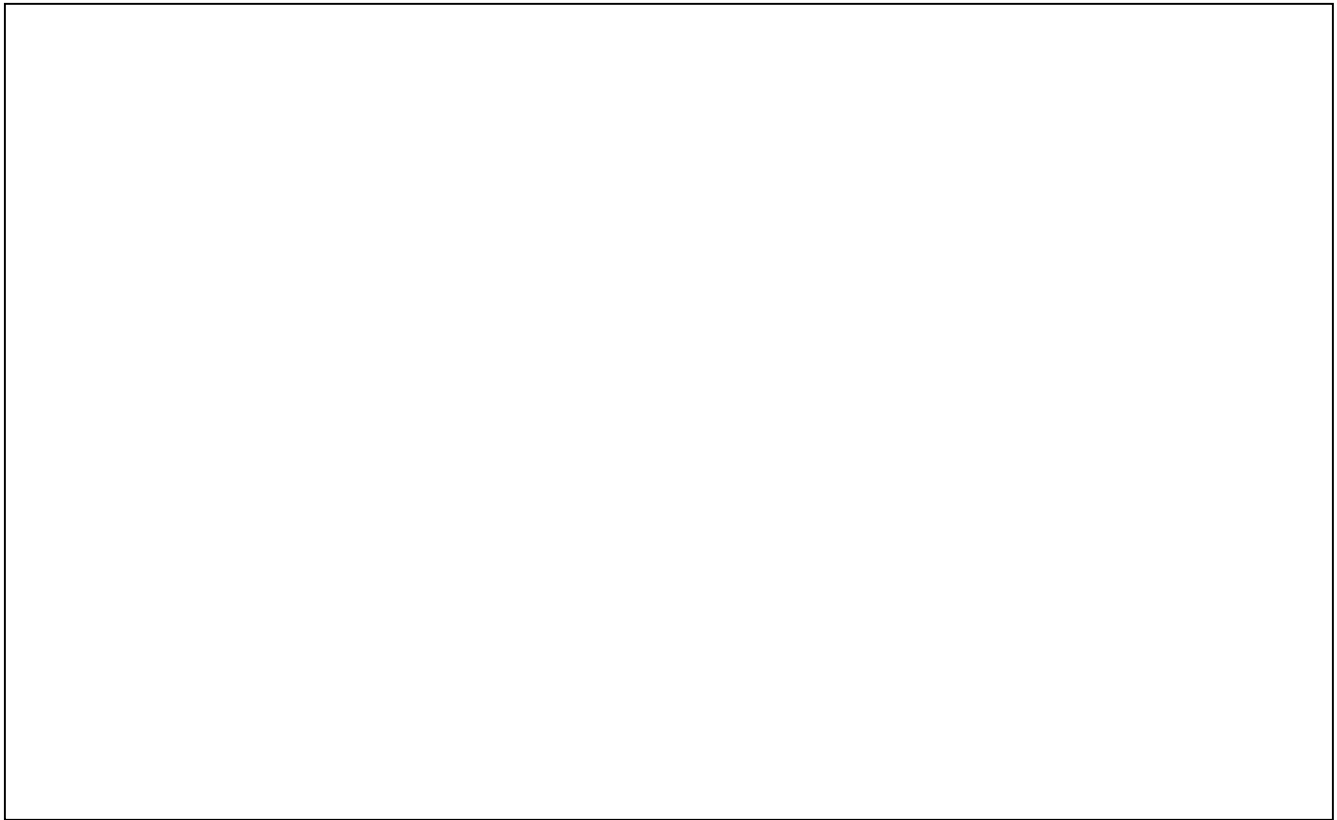

Picture or Drawing, if needed

Designer/Inspector Date

Reviewed by Date
Program Access Coord.

Approved by City Engineer Date

Signature

Signature

Signature

Appendix A: Glossary

Accessible Pedestrian Signal. A device that communicates information about the pedestrian walk phase in non-visual formats such as audible tones, vibrotactile features or auditory announcements.

Island. Curbed or painted area outside of the vehicular path that is provided to separate and direct traffic movement, and which also may serve as a refuge for pedestrians.

Blended Curb or Transition. A curb ramp shallower than 1:20 (5 percent), where the sidewalk is blended into or flush with the street.

Cross Slope. The slope that is perpendicular to the intended direction of travel.

Crosswalk. That part of a roadway at an intersection that is included within the extensions of the lateral lines of the sidewalks on opposite sides of the roadway, measured from the curb line or, in the absence of curbs, from the edges of the roadway or, in the absence of a sidewalk on one side of the roadway, the part of the roadway included within the extension of the lateral lines of the sidewalk at right angles to the centerline.

Marked Crosswalk. Any portion of a roadway at an intersection or elsewhere that is distinctly indicated for pedestrian crossing by lines or other markings on the surface.

Curb. A vertical or rolled transition from the roadway or gutter to the sidewalk or planting strip.

Curb Line. A line at the face of the curb that marks the transition from the roadway or gutter to a sidewalk or planting strip.

Curb Ramp. A ramp cutting through a curb.

Detectable Warning. A surface feature built in or applied to walking surfaces or other elements to warn of hazards on a pedestrian access path.

Driveway. A vehicular path serving a single parcel of private property.

Element. An architectural or mechanical component of a facility, space, site or public right-of-way.

Equivalent Facilitation: A departure from a particular technical or scoping requirement of these standards by the use of other designs and technologies, where the alternative designs and technologies used provide substantially equivalent or greater access to and usability of the element.

Facility. All or any portion of structures, improvements, elements, and pedestrian or vehicular routes located on a site or in a public right-of-way.

Flush Transition. See Blended Transition.

Grade. See Running Slope.

Grade Break. The meeting line of two adjacent surfaces of different slope (grade).

Land Use Zone. The land use of a particular property location, as defined by Title II of the City's Zoning Code.

Locator Tone. A repeating sound that identifies the location of the pedestrian push button.

Parallel Curb Ramp. A system of two sloped ramps that run parallel to the curb line from a common lower landing that is approximately level with the street.

Pedestrian Access Route (Path). Any walk or path intended for pedestrian movement or activity.

Perpendicular Curb Ramp. A curb ramp with a main slope running perpendicular to the curb line, and which may include one or more flared side slopes.

Program Access Requirements. Requirements in the ADA Transition Plan for making the public right-of-way accessible to persons with disabilities.

Public Right-of-Way. Land or property owned by a public entity and usually is acquired for or devoted to transportation or pedestrian purposes.

Ramp. A sloping portion of a walkway with a running slope exceeding five percent.

Running Slope. The slope that is parallel to the direction of travel expressed as a ratio of rise to run, usually expressed in percent.

Sidewalk. That portion of a public right-of-way between the curb line or lateral line of a roadway and the adjacent property line that is improved for use by pedestrians.

Sidewalk Ramp: See Curb Ramp.

Street Furniture. Elements in the public right-of-way that are intended for use by pedestrians.

Tactile Guidestrip. A horizontal strip applied to the walking surface along an accessible pedestrian access route that provides directional cues for persons with low vision or persons who are blind and use a cane.

Technical Infeasibility. With respect to an alteration of an existing element, that it has little likelihood of being accomplished because existing physical or site constraints prohibit modification or addition of elements, spaces or features that are in full and strict compliance with the minimum requirements for new construction and that are necessary to provide accessibility.

Walk Interval. The phase of a traffic signal cycle during which the pedestrian is to begin crossing, typically indicated by a walk message or the walking person symbol and its audible equivalent.

Appendix B: Standard City Improvement Drawings

(Note: Drawing numbers shown refer to numbers assigned by the City Improvement Standards, not by the ADA Transition Plan)

- 4-1 Alley Details and Driveway Transitions
- 4-13 Typical Street Sections at Residential Driveways
- 4-14 Commercial Driveways Type A-6
- 4-15A Special Commercial Frontage Entrance Type A-7
- 4-15B Sidewalk Ramp for Type A-7 Driveways without Additional R/W
- 4-21 Bus Turnout
- 4-22 Bus Stop
- 4-23A Sidewalk Ramp Detail
- 4-23B Sidewalk Ramp Detail for Plaza Areas
- 4-23C A.C. Conforms to New Sidewalk Ramp Construction
- 4-24 Curb Ramp Placement
- 4-25 Curbs and Gutter
- 4-26 Cross Gutter
- 4-27 Barrier Curb Detail
- 4-28 Under Sidewalk Drain
- 4-29 Meandering Sidewalk Standards
- 4-32 Pavement Widening Detail
- 4-33 Street Sign Fully Reflectorized
- 4-34 Street Name Sign Placement Details
- 4-35 Street Name Sign on Street Light Pole Placement Detail
- 4-36 Street Name Sign Installation on Street Light Pole
- 4-37 Street Name Sign Placement Details
- 4-39 Signs and Barricades at Abrupt Change of Pavement Width
- 4-40 Sidewalk Barricade
- 4-41 Utility Pole Placement Locations
- 4-42 A.C. Sidewalk Conform
- 4-43 Sidewalk Concrete Joint Details

For an alternate format, refer to the corresponding text in Section 5.

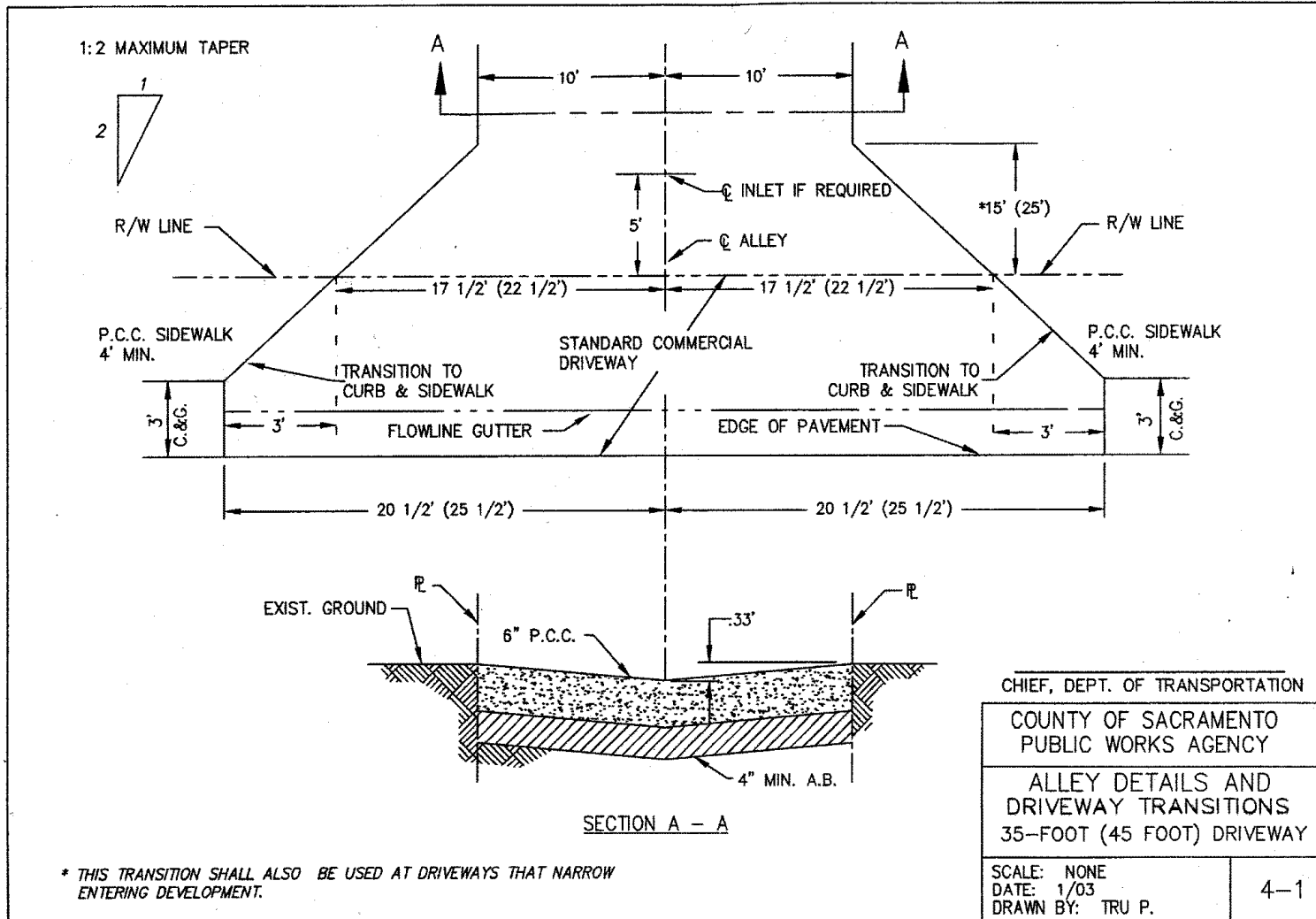

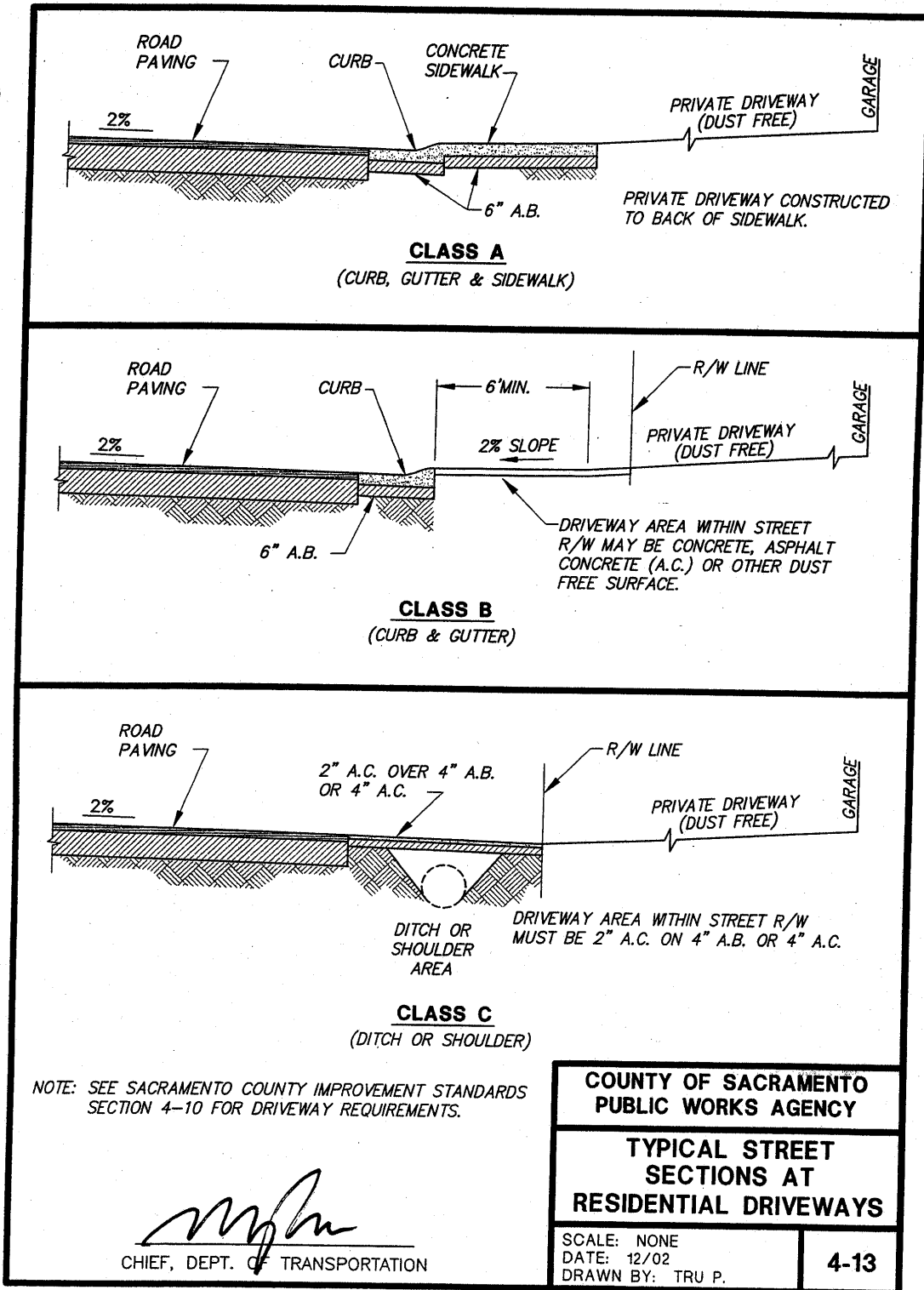

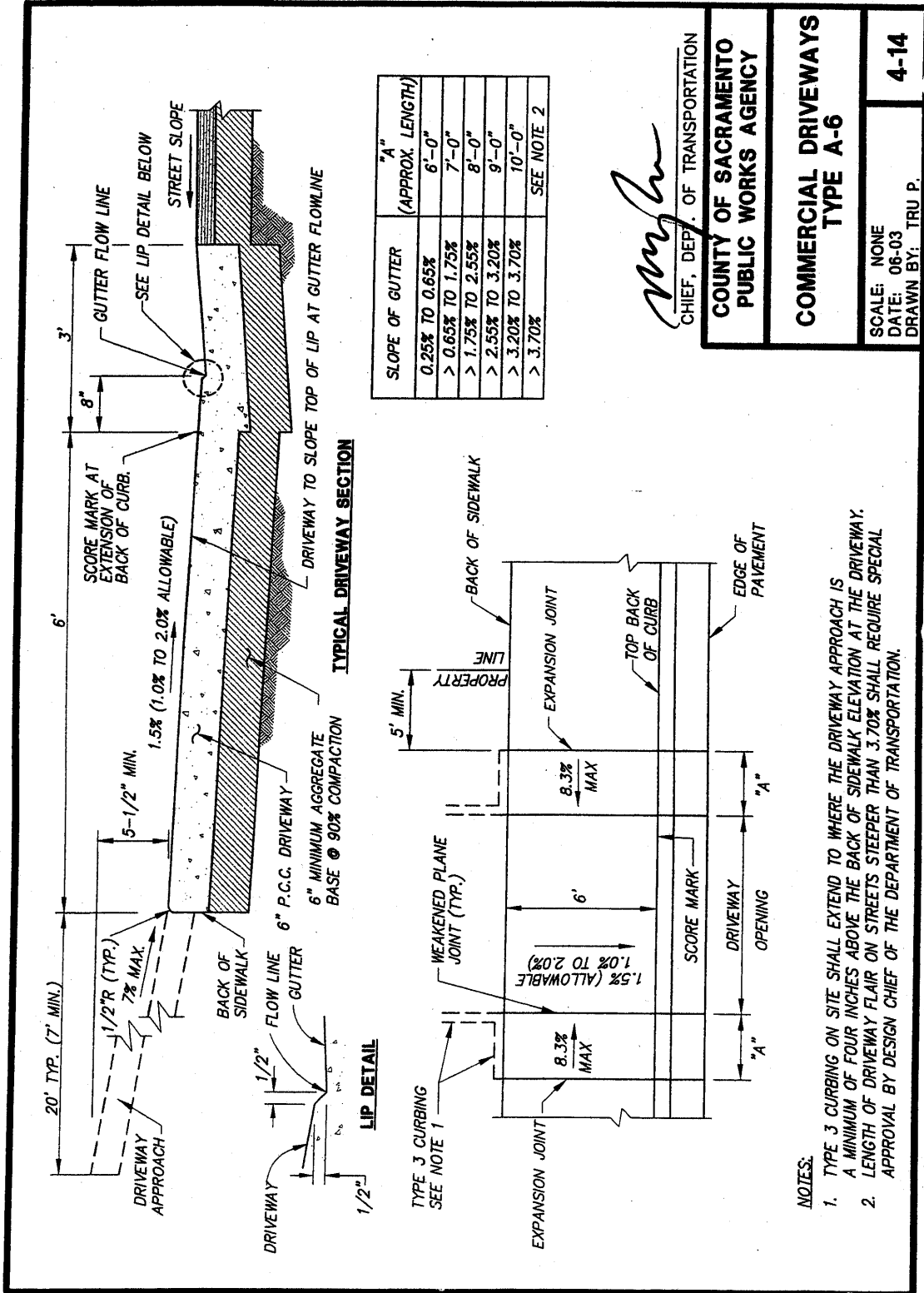

Myler
 CHIEF, DEPT. OF TRANSPORTATION
**COUNTY OF SACRAMENTO
 PUBLIC WORKS AGENCY**
**COMMERCIAL DRIVEWAYS
 TYPE A-6**
 SCALE: NONE
 DATE: 06-03
 DRAWN BY: TRU P.
4-14

- NOTES:**
- TYPE 3 CURBING ON SITE SHALL EXTEND TO WHERE THE DRIVEWAY APPROACH IS A MINIMUM OF FOUR INCHES ABOVE THE BACK OF SIDEWALK ELEVATION AT THE DRIVEWAY.
 - LENGTH OF DRIVEWAY FLAIR ON STREETS STEEPER THAN 3.70% SHALL REQUIRE SPECIAL APPROVAL BY DESIGN CHIEF OF THE DEPARTMENT OF TRANSPORTATION.

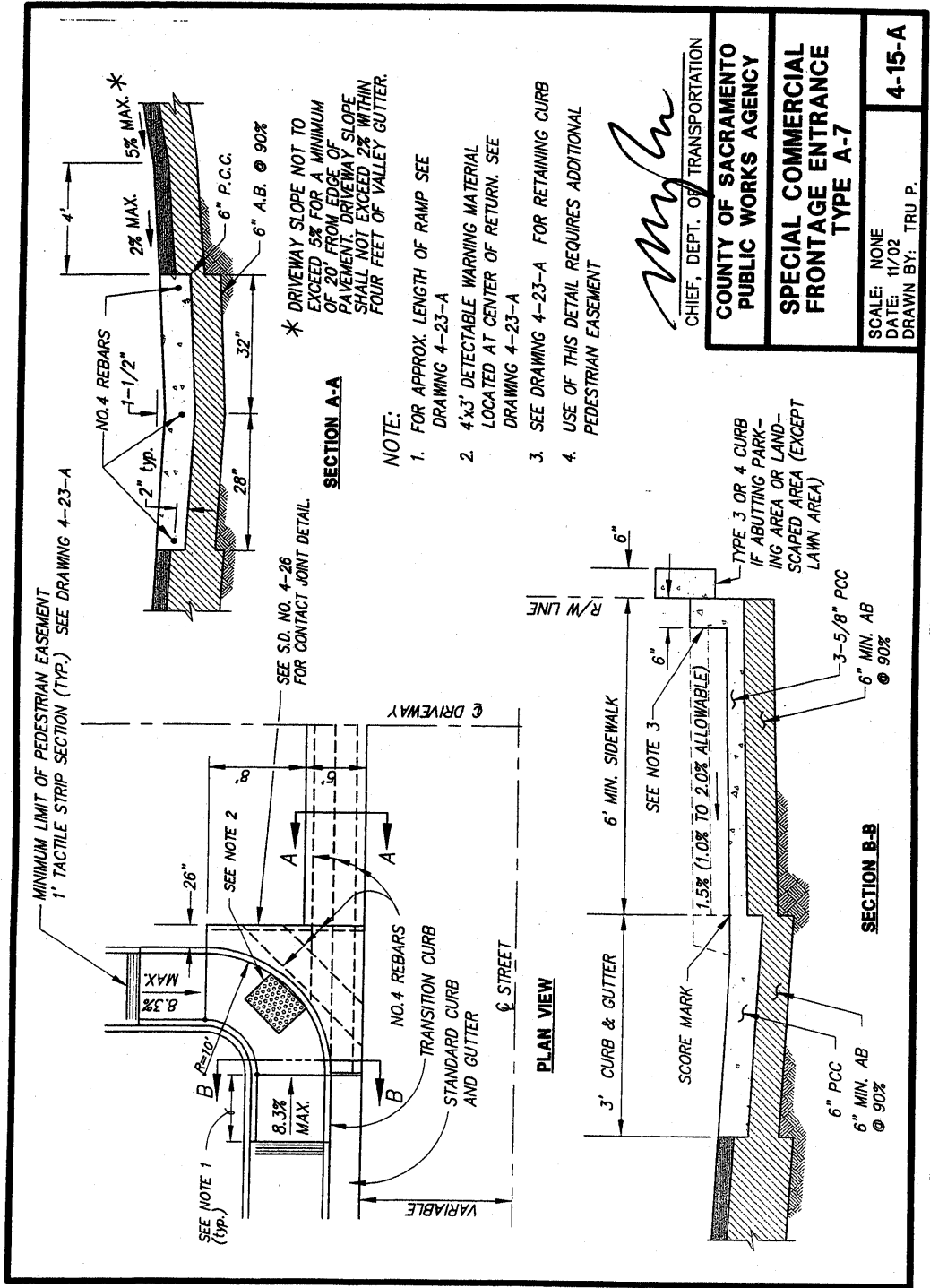

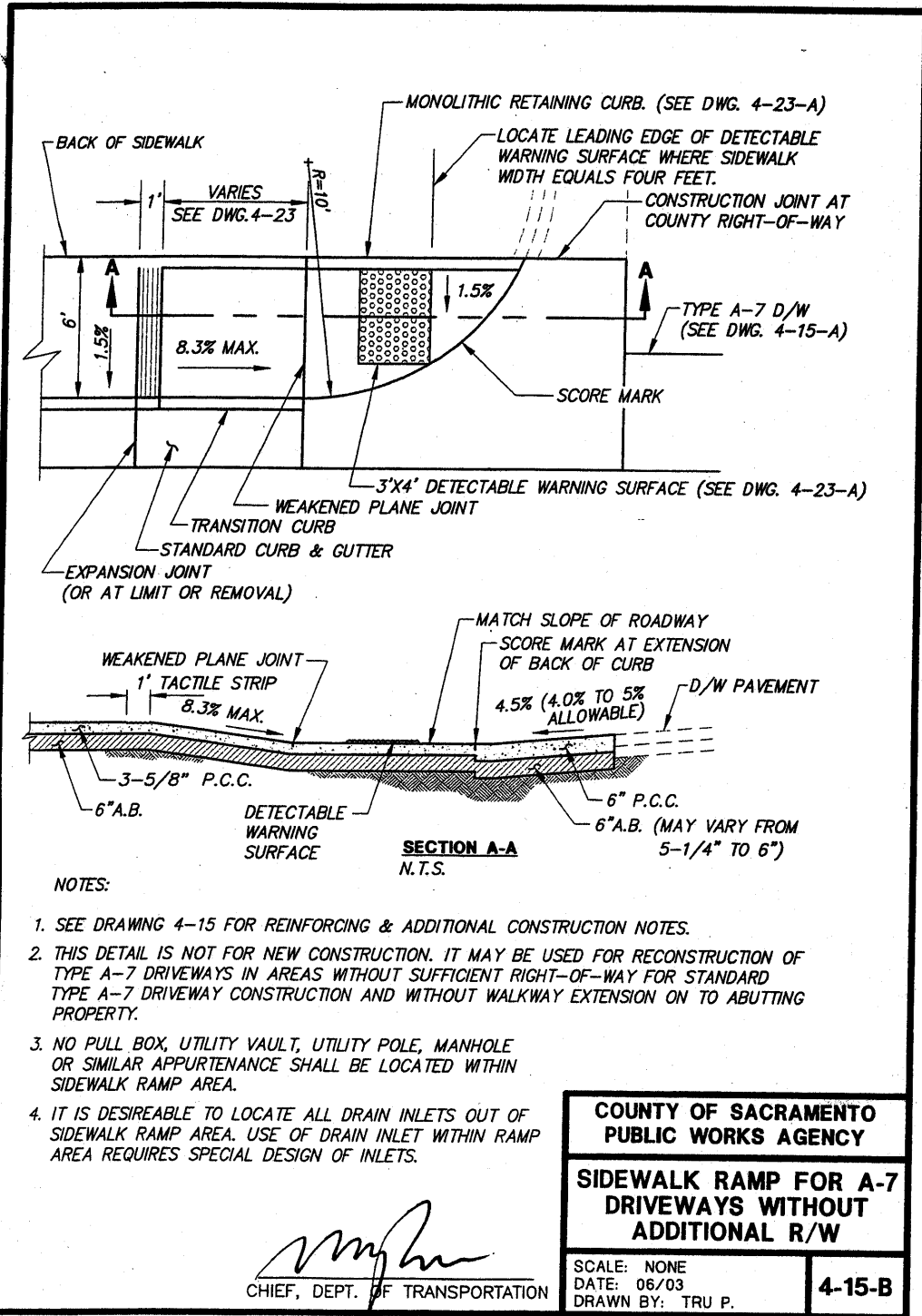

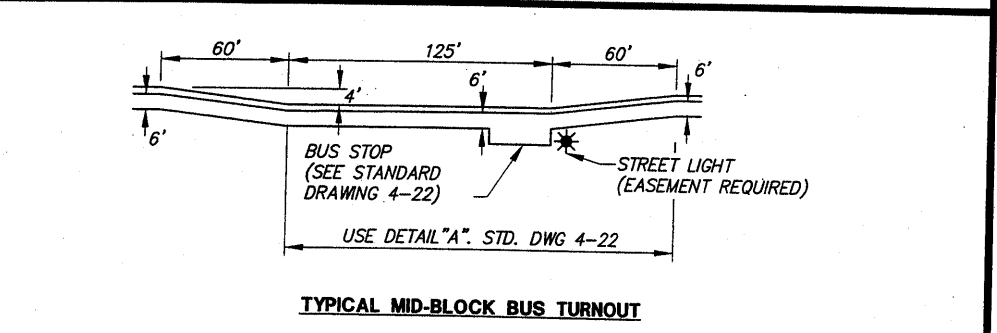
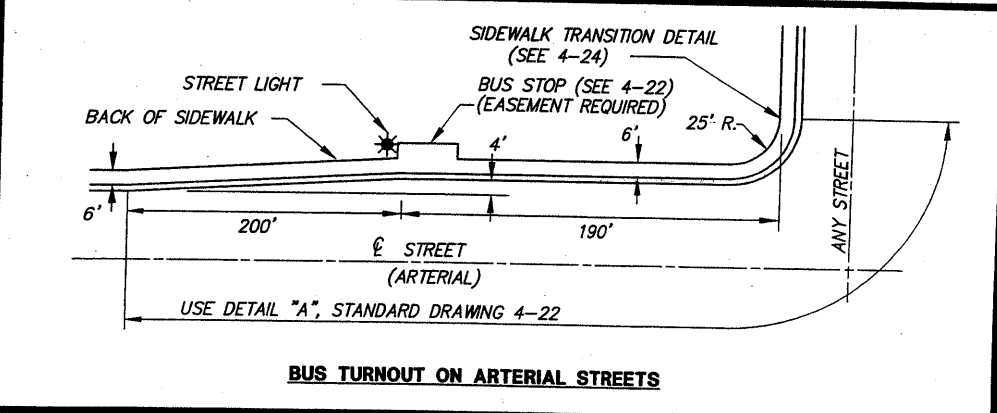
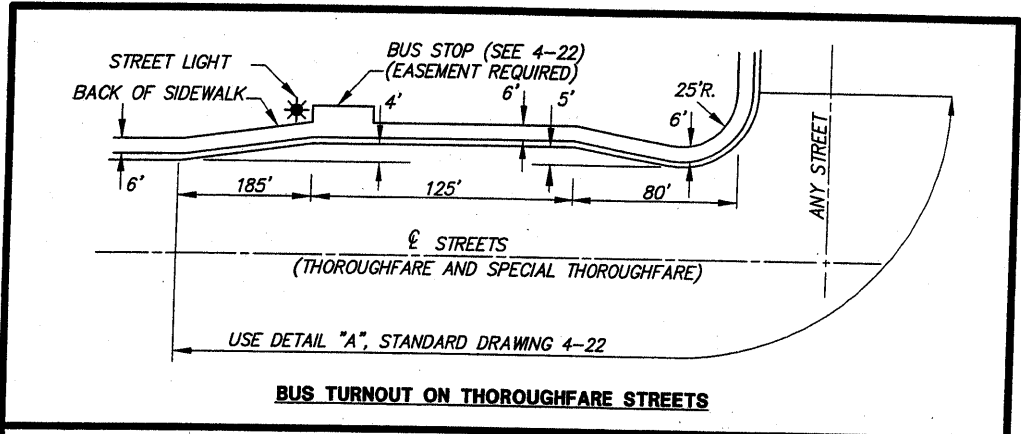

[Signature]
 CHIEF, DEPT. OF TRANSPORTATION

COUNTY OF SACRAMENTO PUBLIC WORKS AGENCY	
BUS TURNOUTS	
SCALE: NONE DATE: 11/27/02 DRAWN BY: TRU P.	4-21

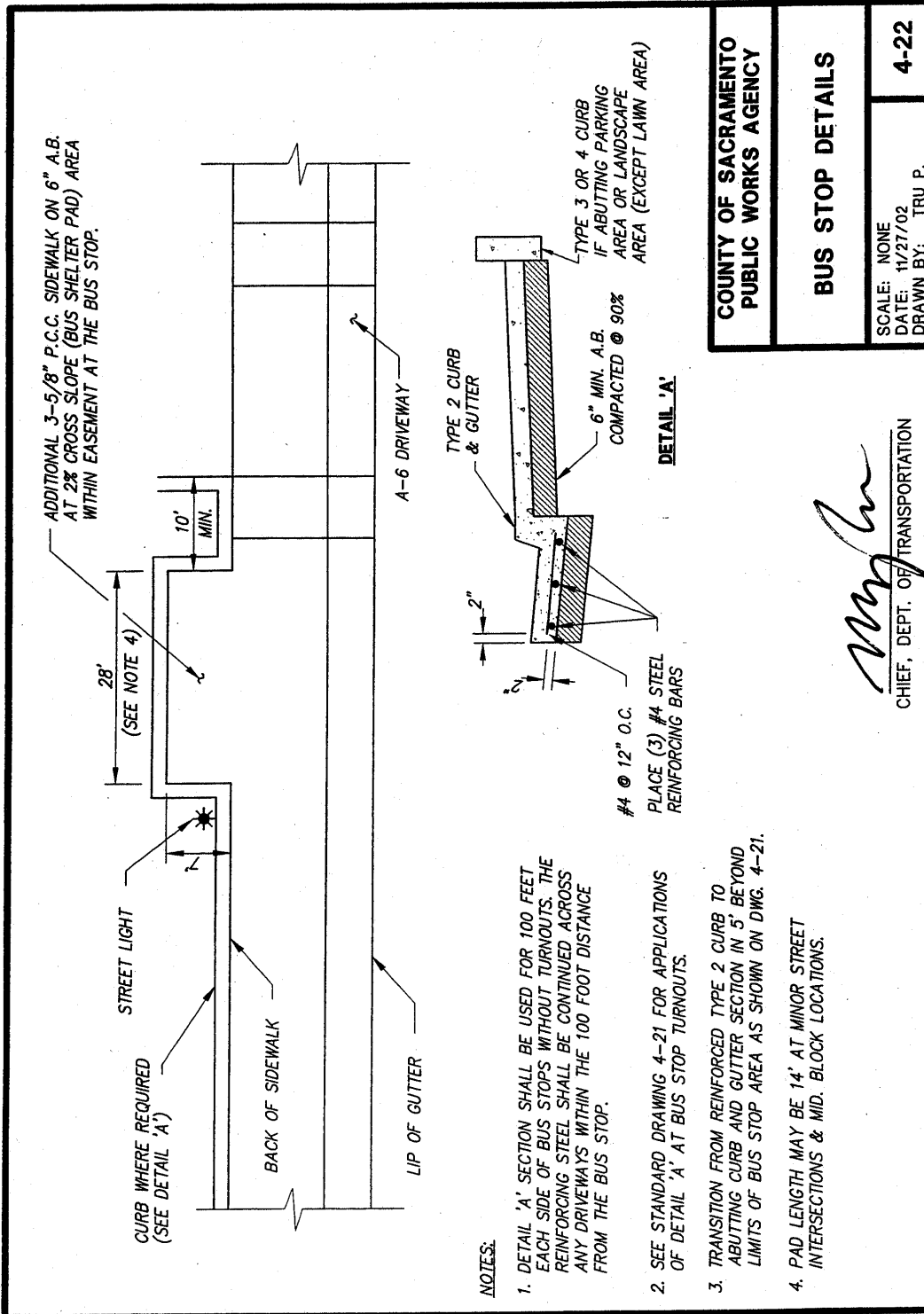

COUNTY OF SACRAMENTO PUBLIC WORKS AGENCY	
BUS STOP DETAILS	
SCALE: NONE	DATE: 11/27/02
DRAWN BY: TRU P.	
4-22	

M. J. ...
CHIEF, DEPT. OF TRANSPORTATION

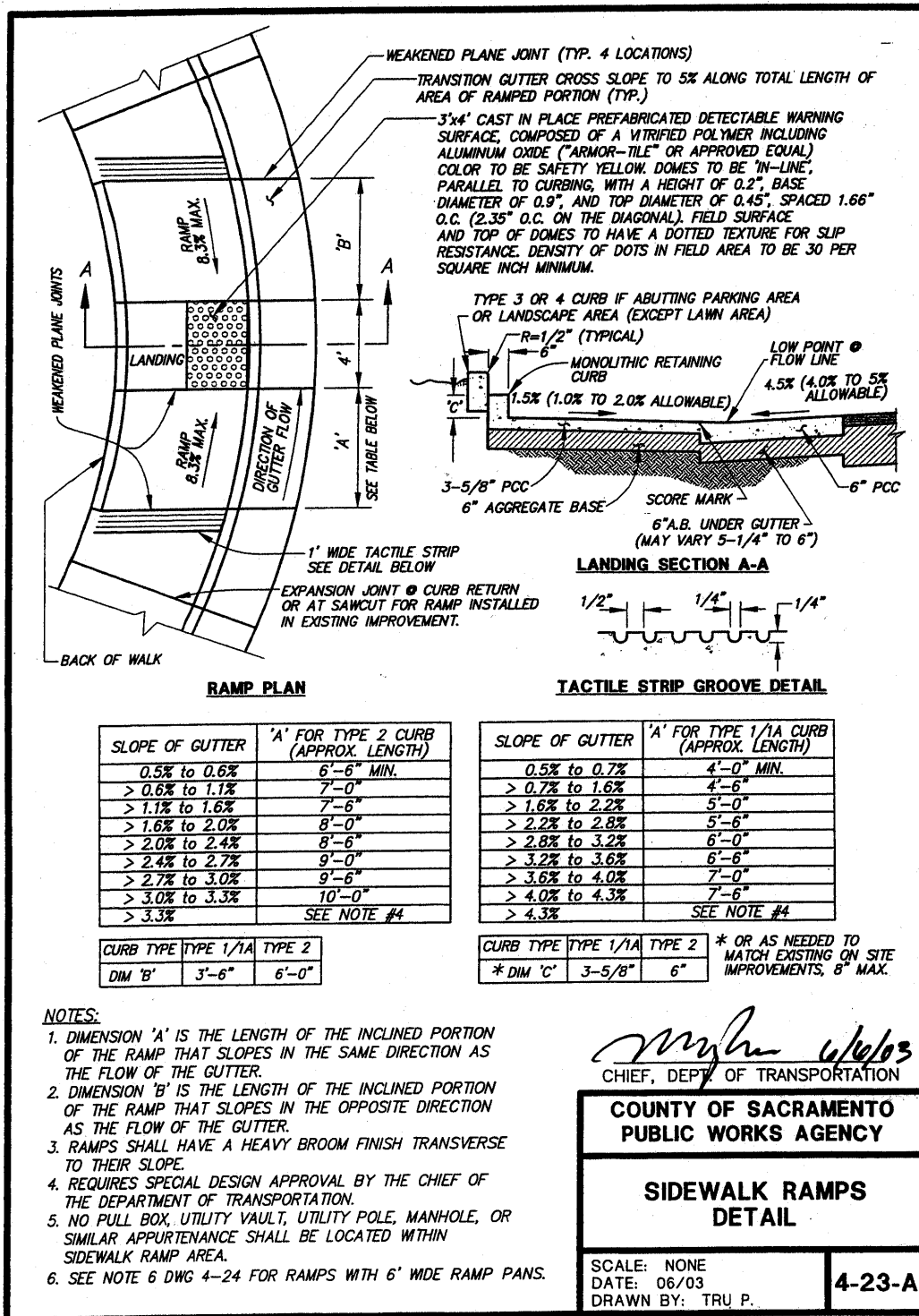

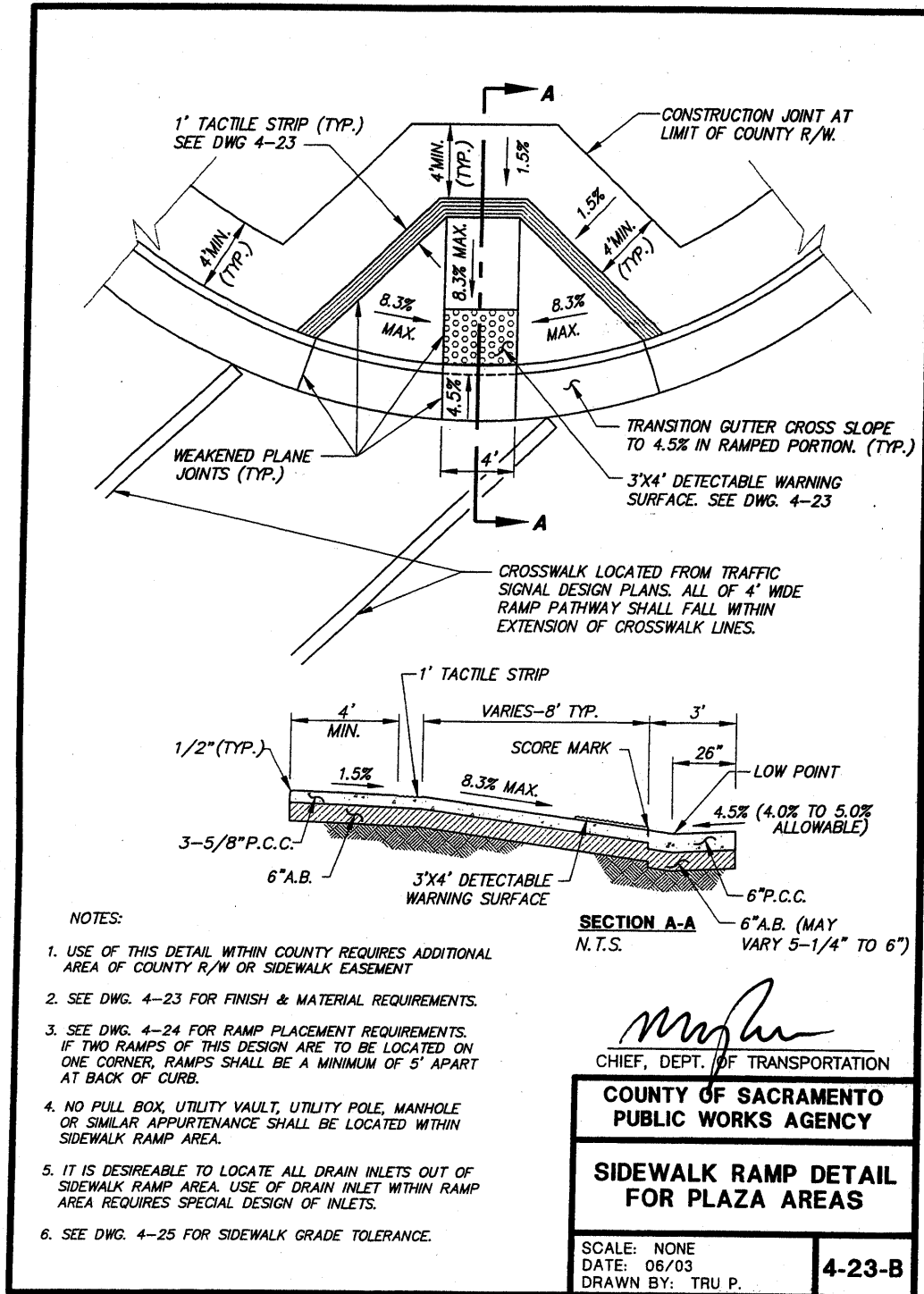

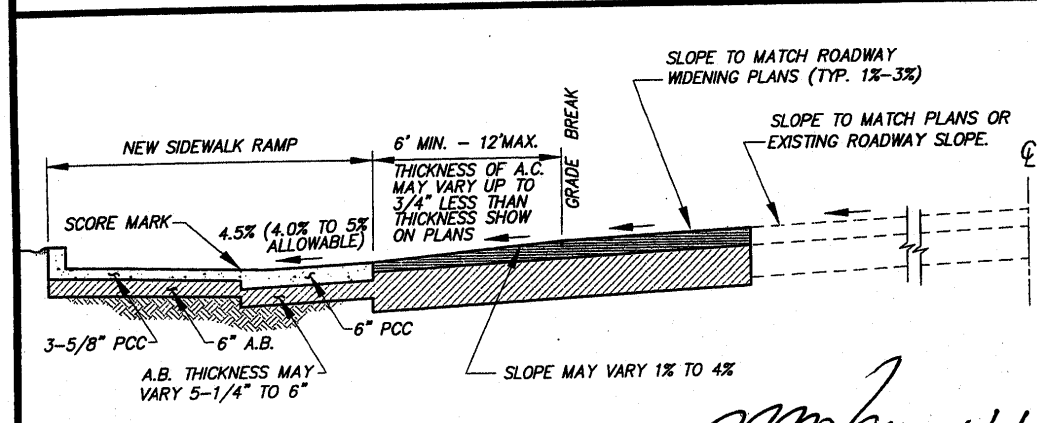
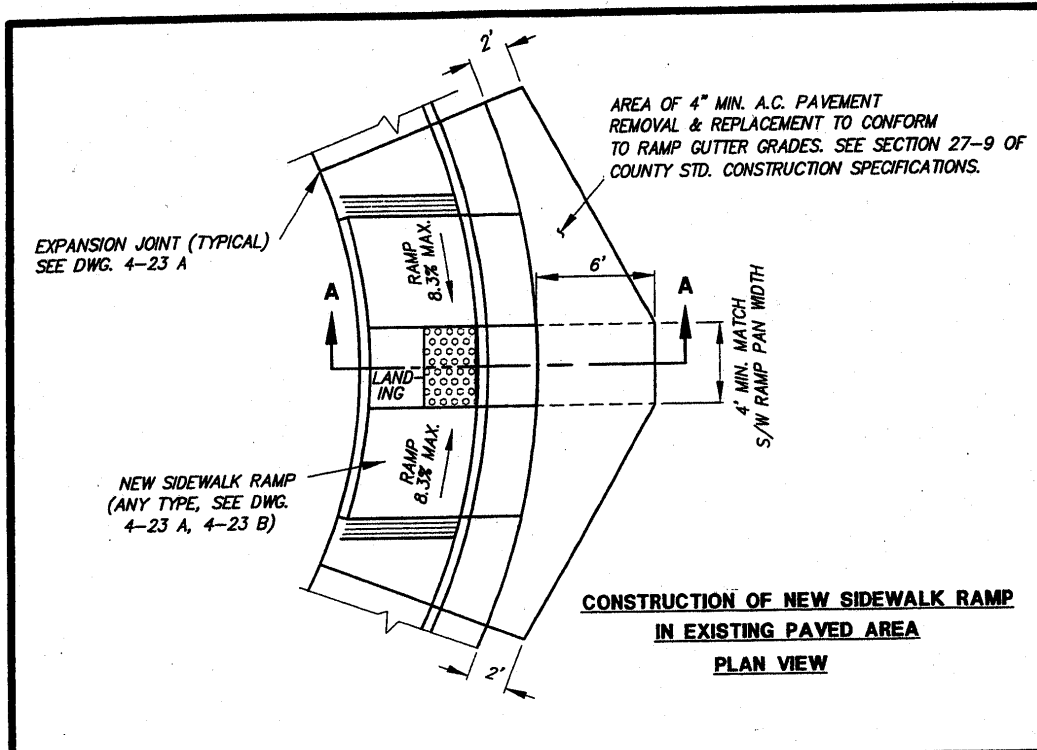

CONSTRUCTION OF NEW SIDEWALK RAMP
WITH PAVEMENT WIDENING
SECTION A - A

Tru P. 6/6/03
CHIEF, DEPT. OF TRANSPORTATION

<p>COUNTY OF SACRAMENTO PUBLIC WORKS AGENCY</p>	
<p>A.C. CONFORMS TO NEW SIDEWALK RAMP CONSTRUCTION</p>	
<p>SCALE: NONE DATE: 06/03 DRAWN BY: TRU P.</p>	<p>4-23-C</p>

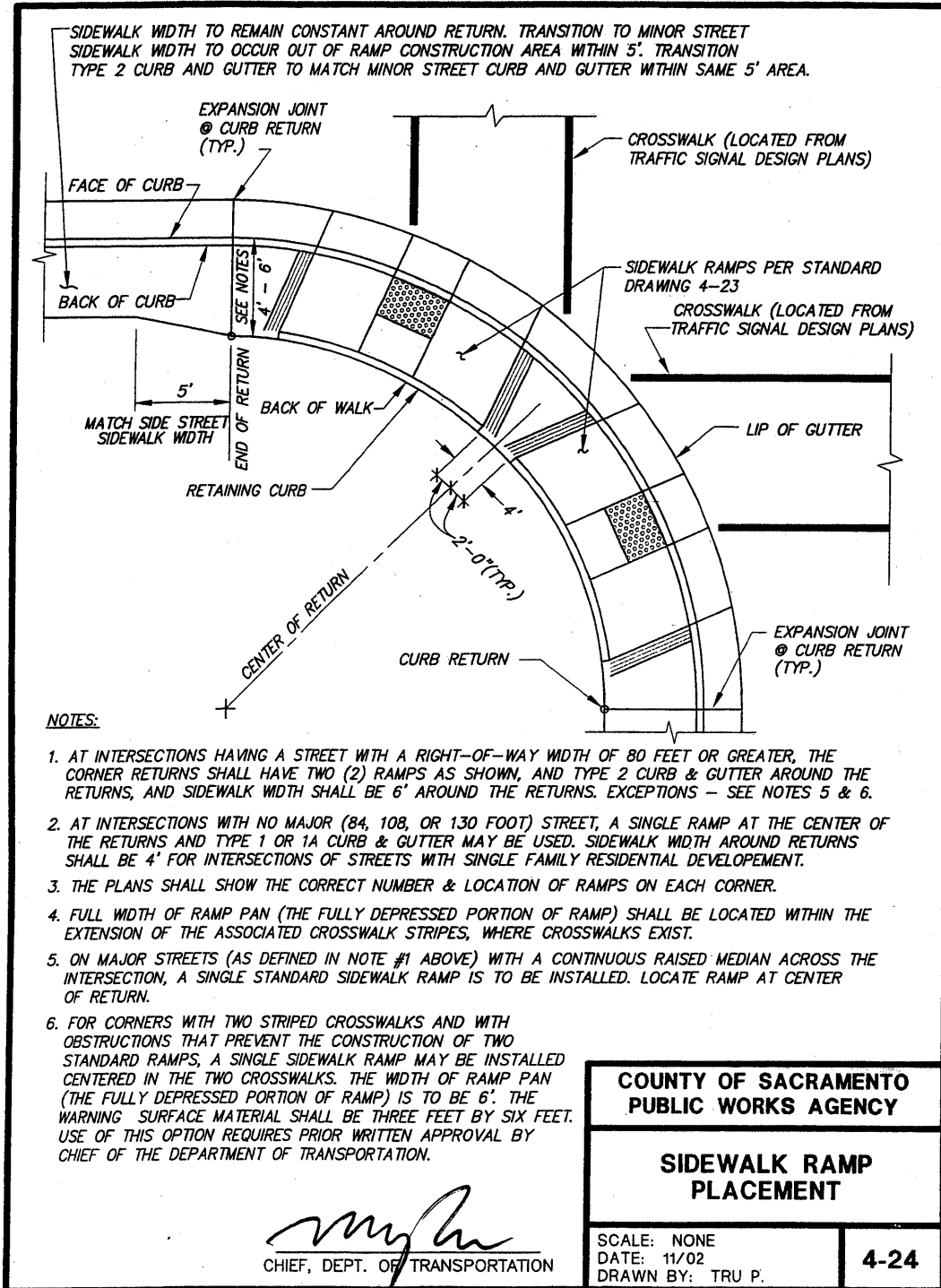

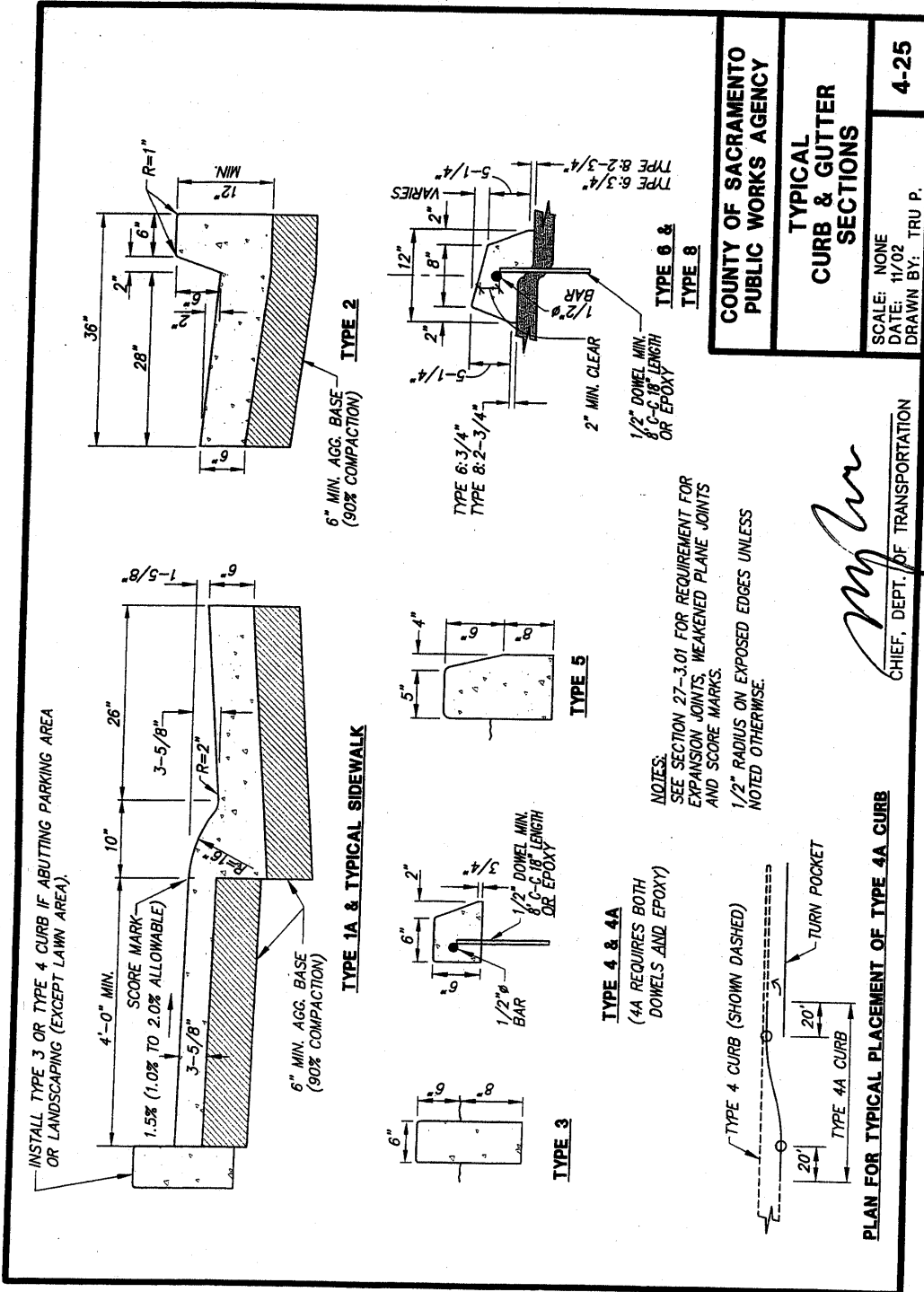

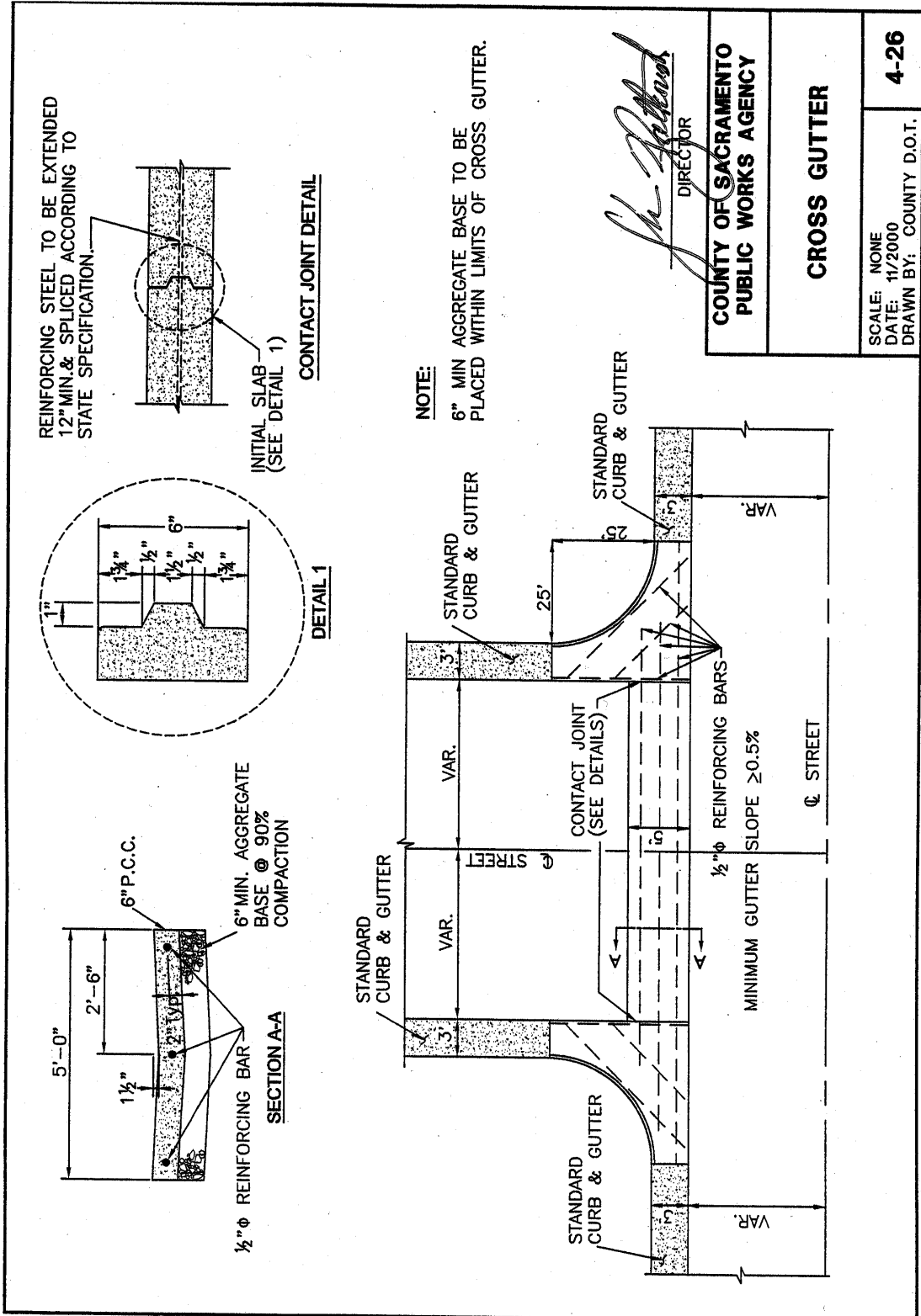

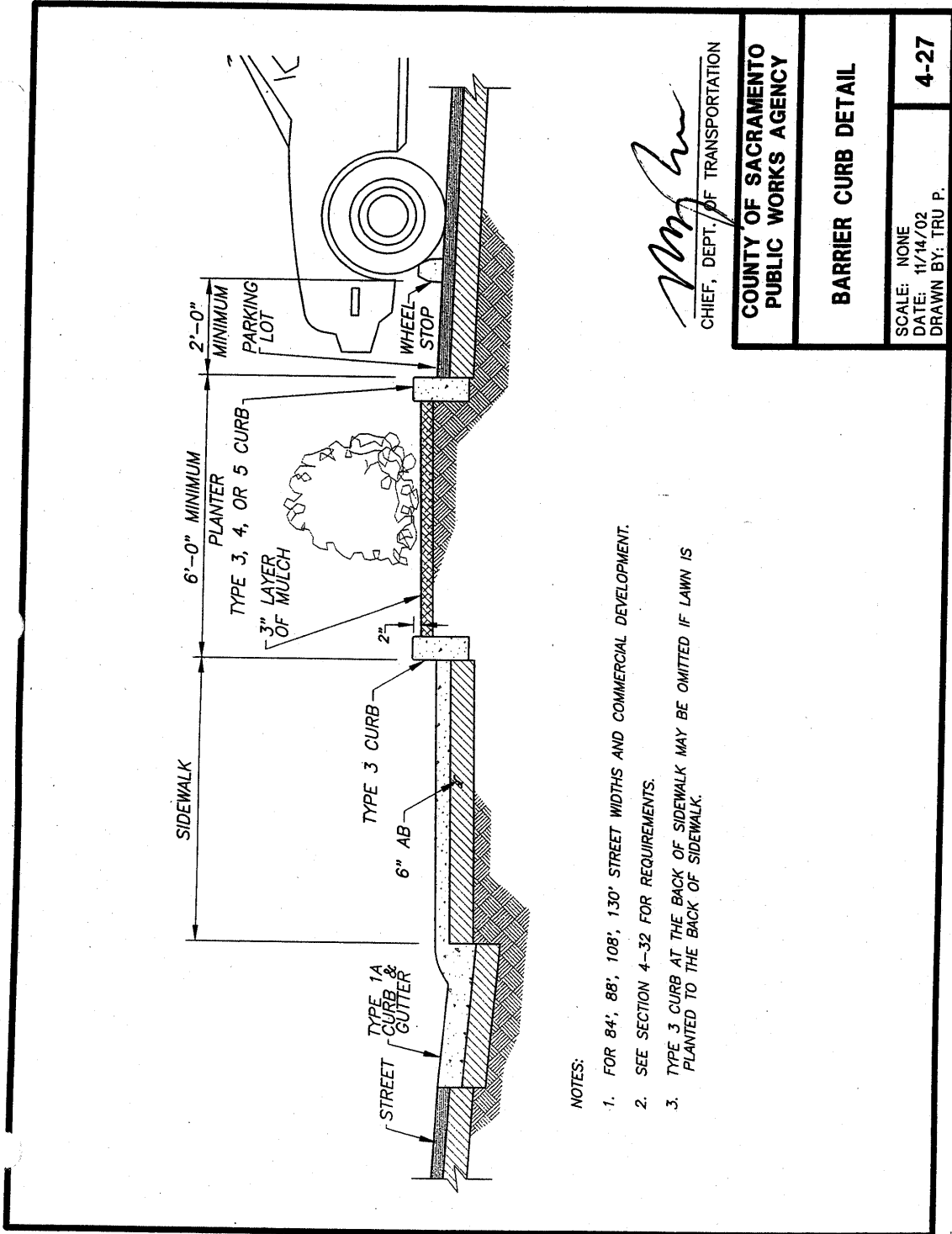

[Signature]
 CHIEF, DEPT. OF TRANSPORTATION

COUNTY OF SACRAMENTO PUBLIC WORKS AGENCY	
BARRIER CURB DETAIL	
SCALE: NONE	4-27
DATE: 11/14/02 DRAWN BY: TRU P.	

- NOTES:
1. FOR 84', 88', 108', 130' STREET WIDTHS AND COMMERCIAL DEVELOPMENT.
 2. SEE SECTION 4-32 FOR REQUIREMENTS.
 3. TYPE 3 CURB AT THE BACK OF SIDEWALK MAY BE OMITTED IF LAWN IS PLANTED TO THE BACK OF SIDEWALK.

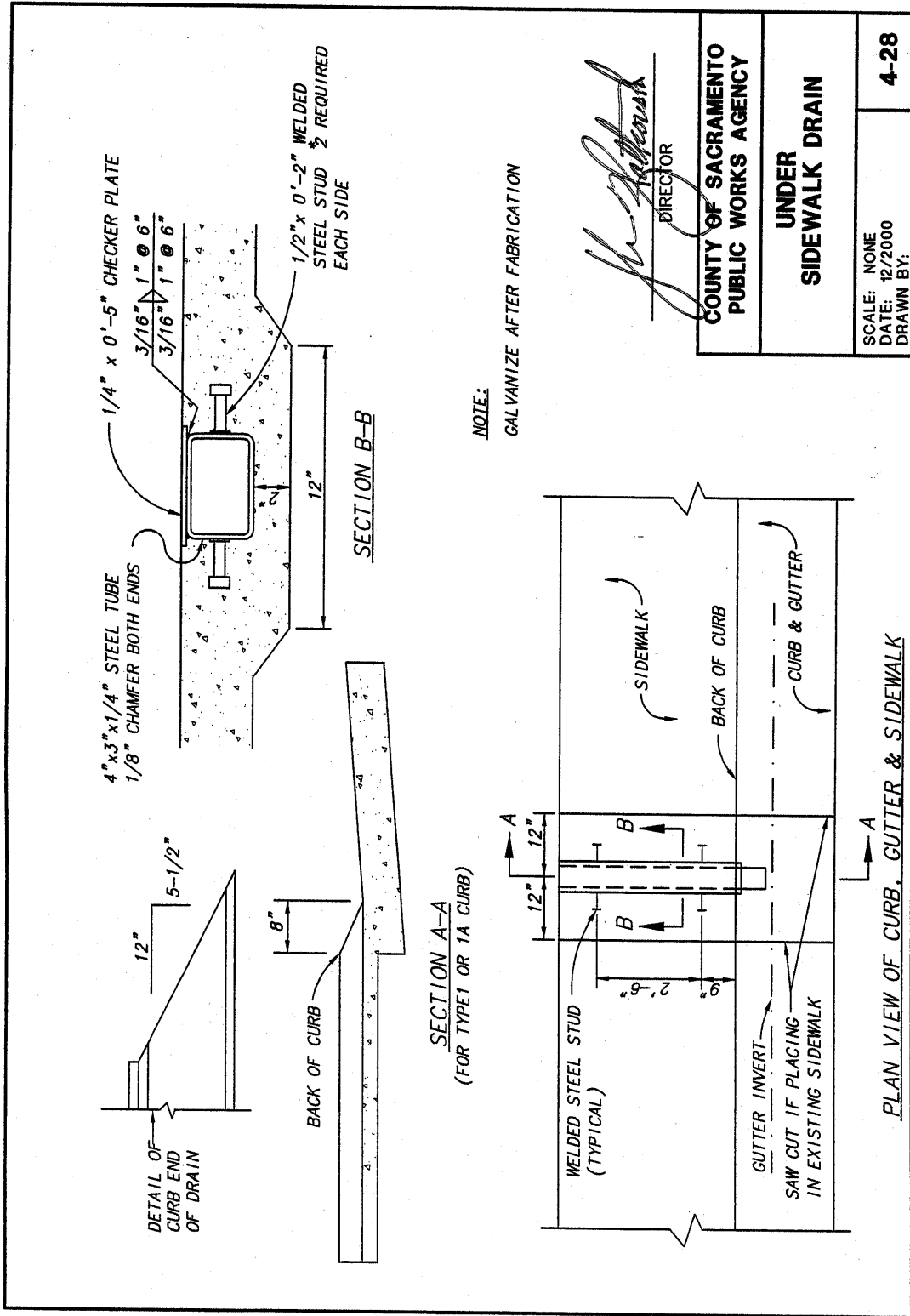

[Signature]
DIRECTOR

COUNTY OF SACRAMENTO PUBLIC WORKS AGENCY	
UNDER SIDEWALK DRAIN	
SCALE: NONE DATE: 12/2000 DRAWN BY:	4-28

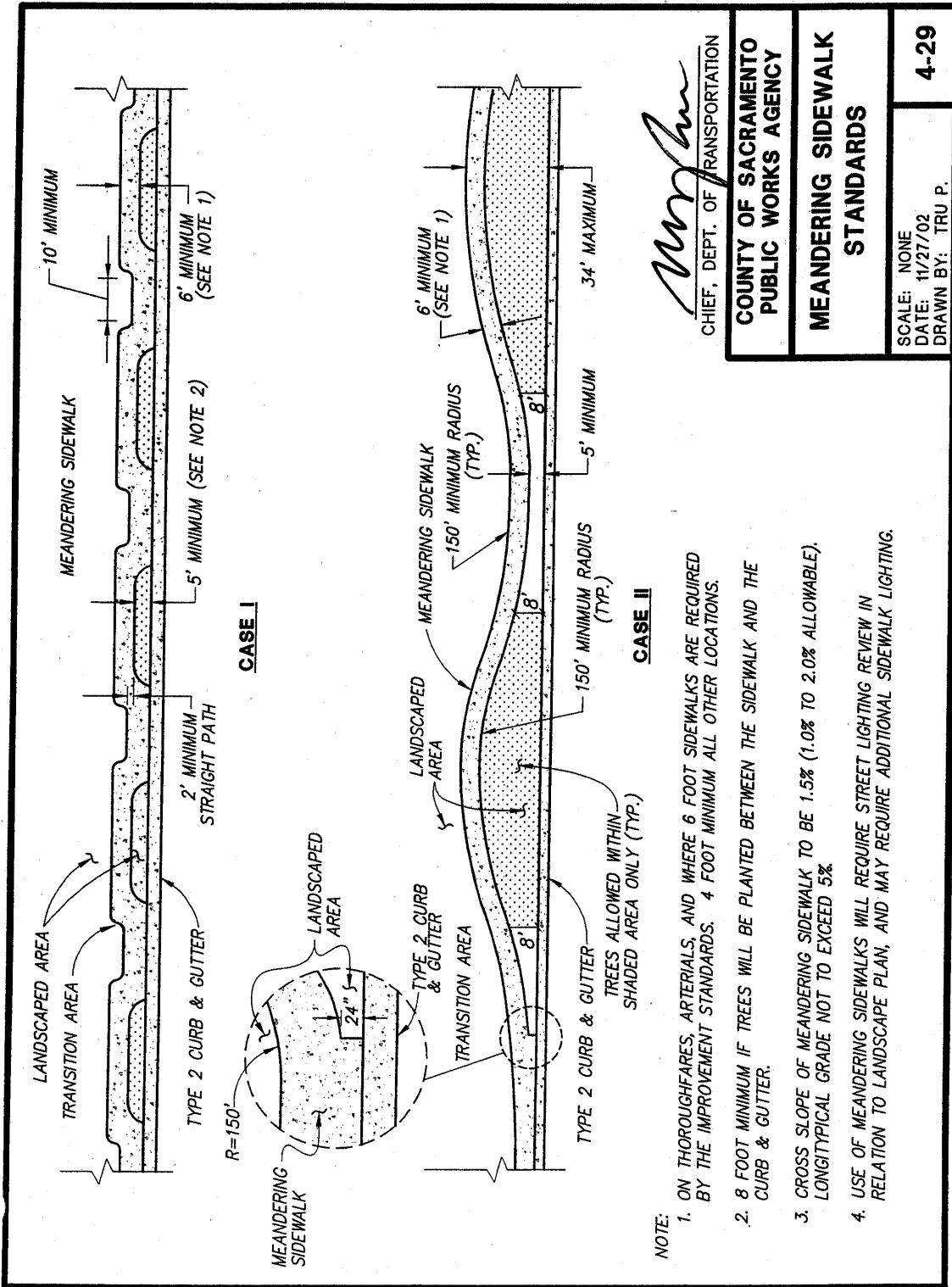

Tru P.
CHIEF, DEPT. OF TRANSPORTATION

**COUNTY OF SACRAMENTO
PUBLIC WORKS AGENCY**

**MEANDERING SIDEWALK
STANDARDS**

SCALE: NONE
DATE: 11/27/02
DRAWN BY: TRU P.

4-29

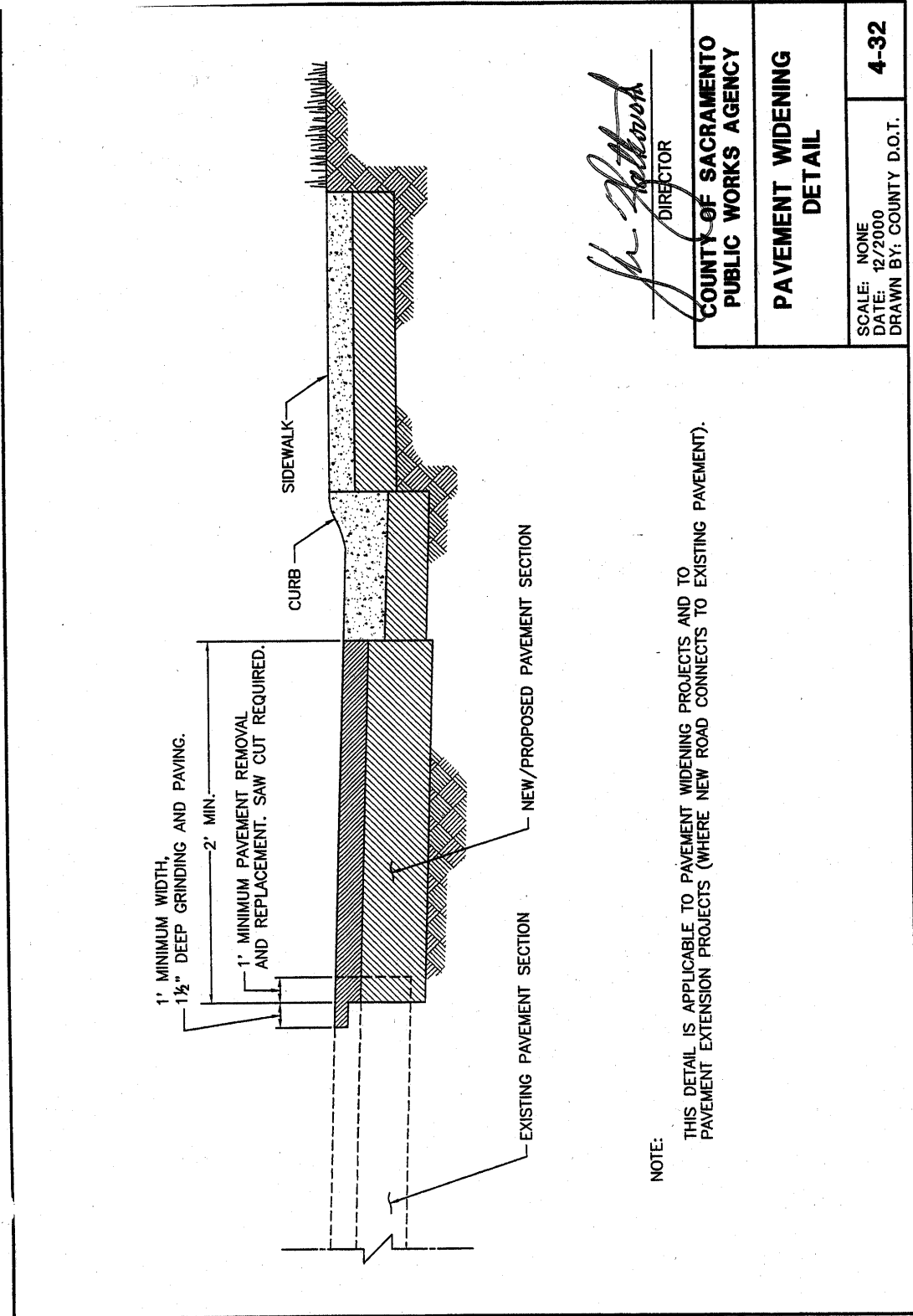

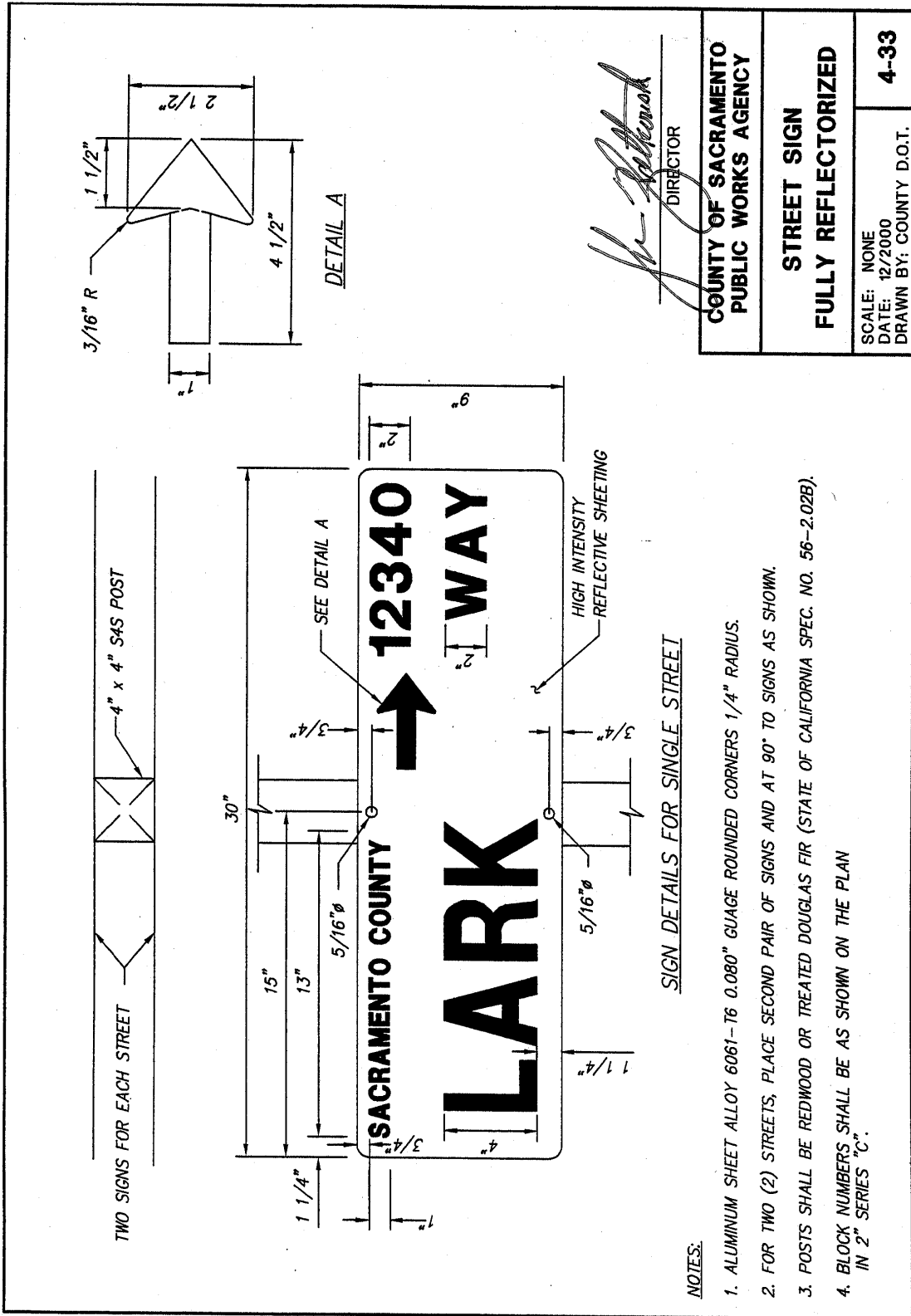

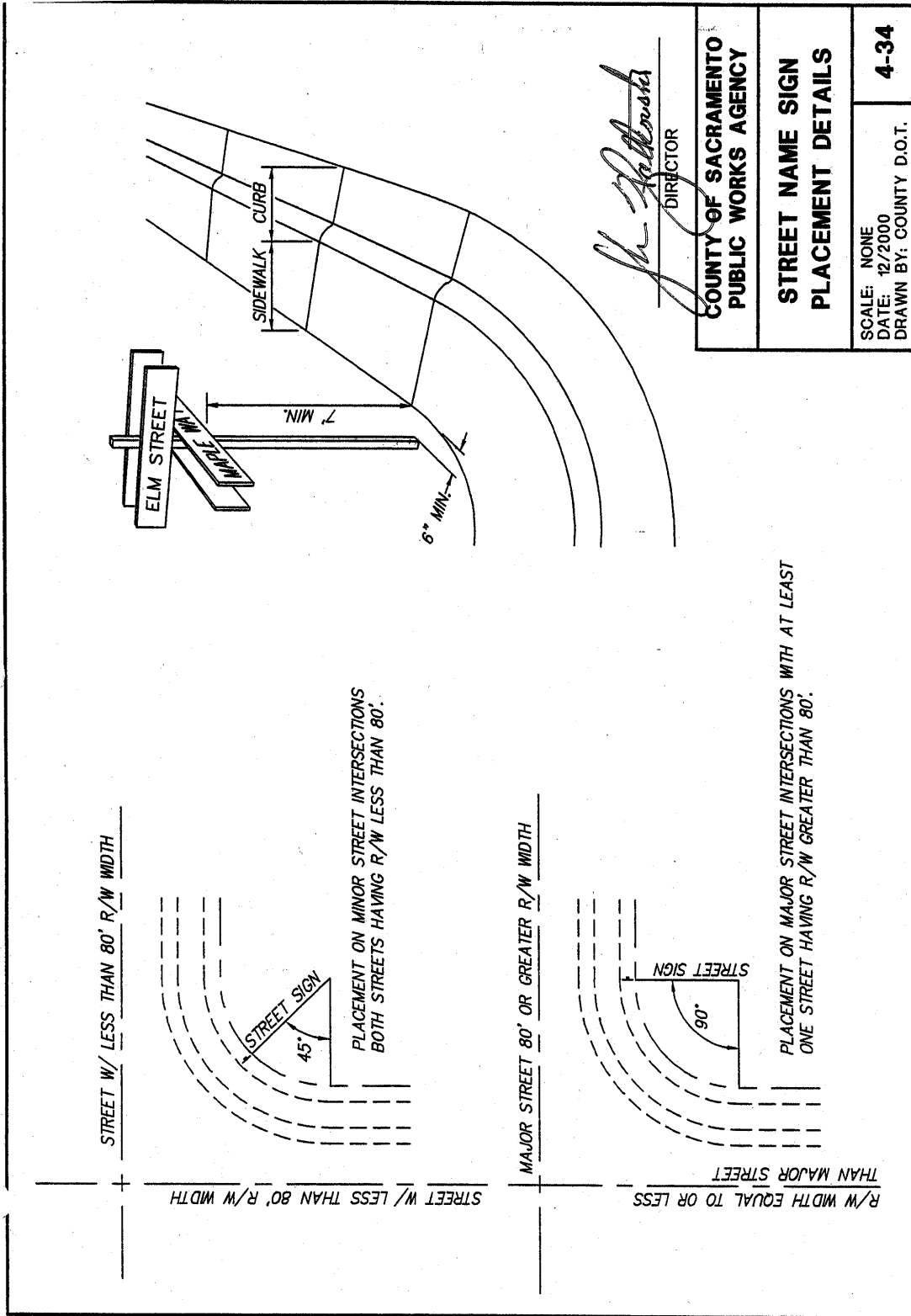

J. Hall
 DIRECTOR

COUNTY OF SACRAMENTO PUBLIC WORKS AGENCY	
STREET NAME SIGN PLACEMENT DETAILS	
SCALE: NONE DATE: 12/2000 DRAWN BY: COUNTY D.O.T.	4-34

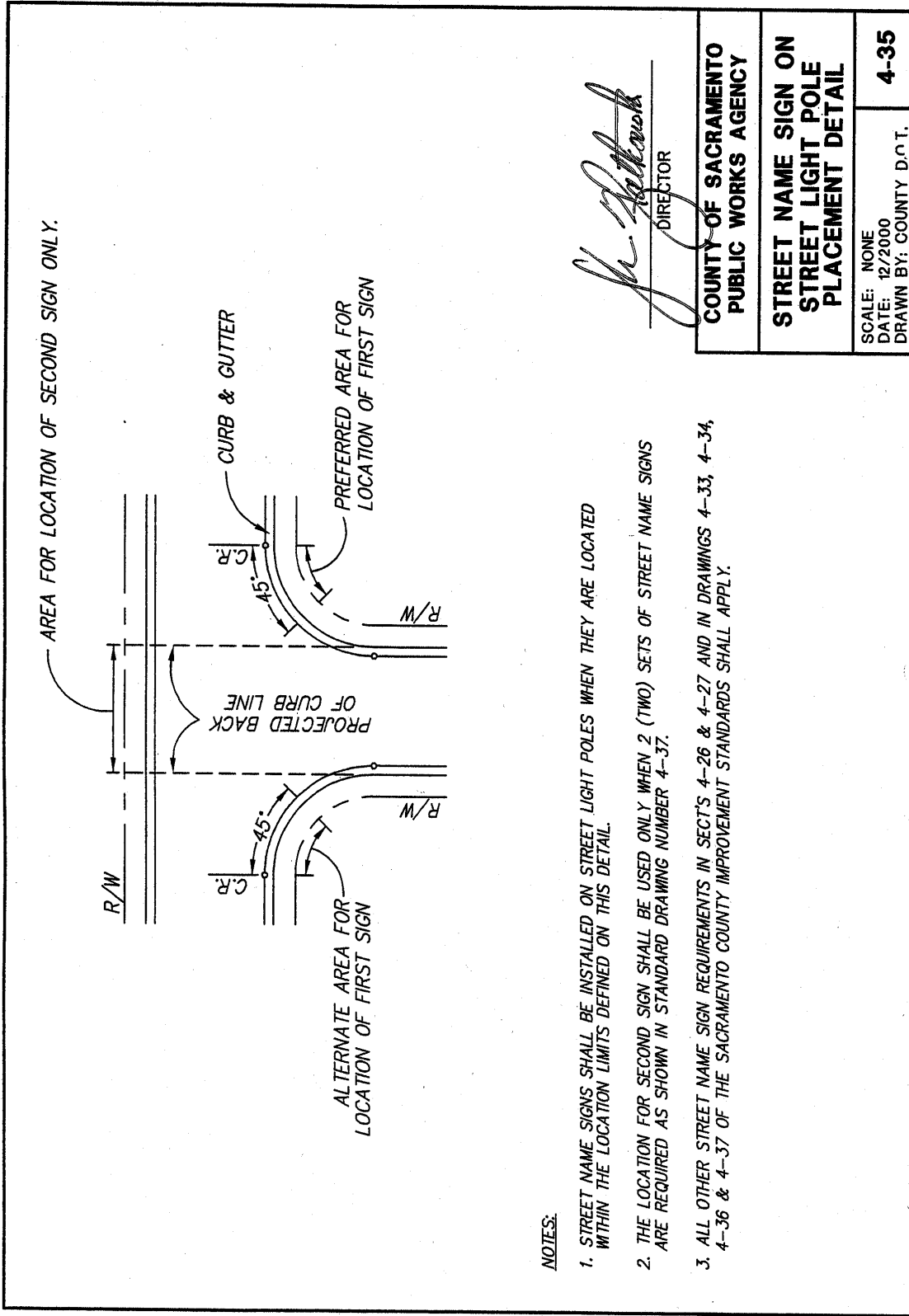

NOTES:

1. STREET NAME SIGNS SHALL BE INSTALLED ON STREET LIGHT POLES WHEN THEY ARE LOCATED WITHIN THE LOCATION LIMITS DEFINED ON THIS DETAIL.
2. THE LOCATION FOR SECOND SIGN SHALL BE USED ONLY WHEN 2 (TWO) SETS OF STREET NAME SIGNS ARE REQUIRED AS SHOWN IN STANDARD DRAWING NUMBER 4-37.
3. ALL OTHER STREET NAME SIGN REQUIREMENTS IN SECT'S 4-26 & 4-27 AND IN DRAWINGS 4-33, 4-34, 4-36 & 4-37 OF THE SACRAMENTO COUNTY IMPROVEMENT STANDARDS SHALL APPLY.

[Signature]
 DIRECTOR

COUNTY OF SACRAMENTO PUBLIC WORKS AGENCY	
STREET NAME SIGN ON STREET LIGHT POLE PLACEMENT DETAIL	
SCALE: NONE DATE: 12/2000 DRAWN BY: COUNTY D.O.T.	4-35

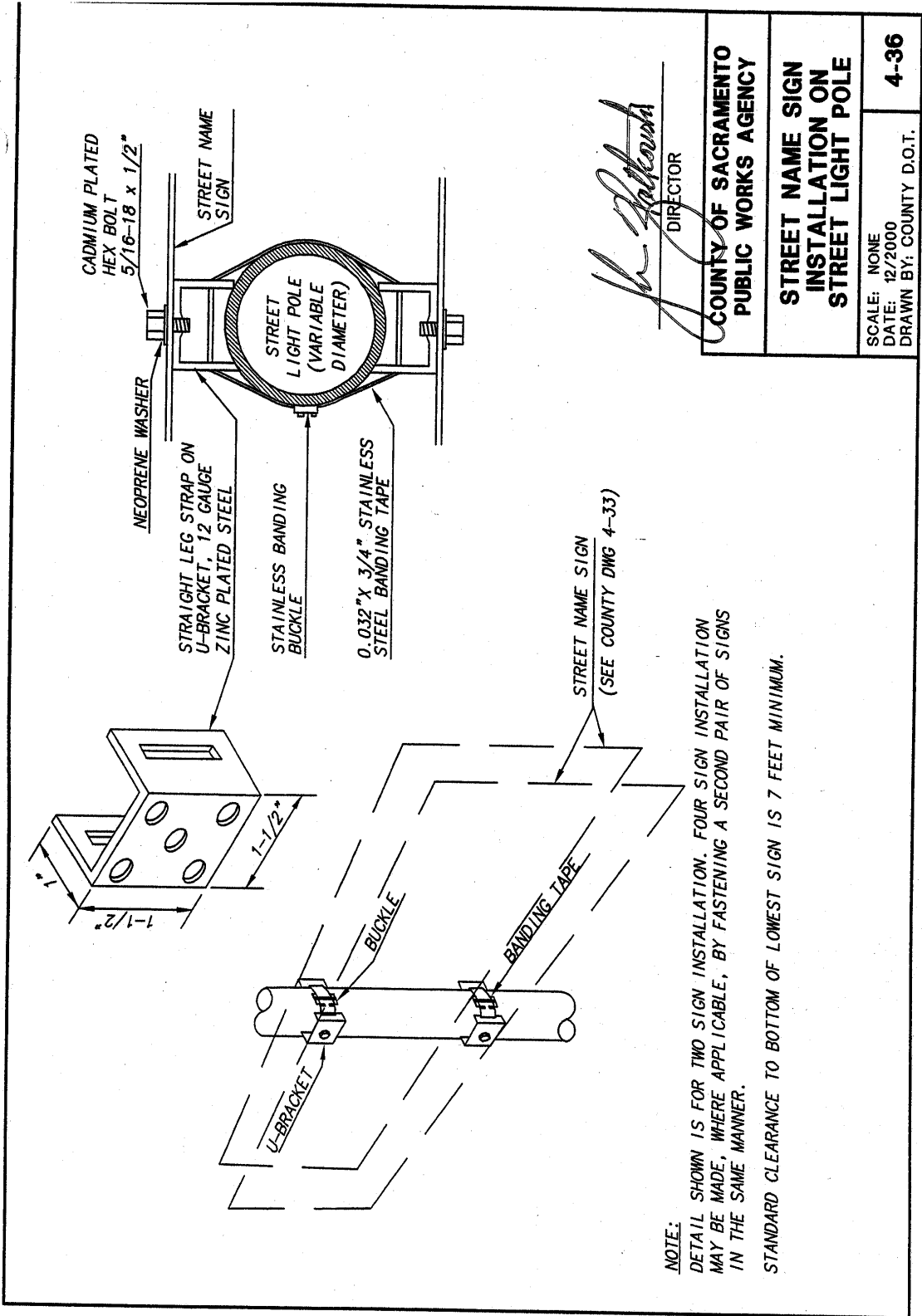

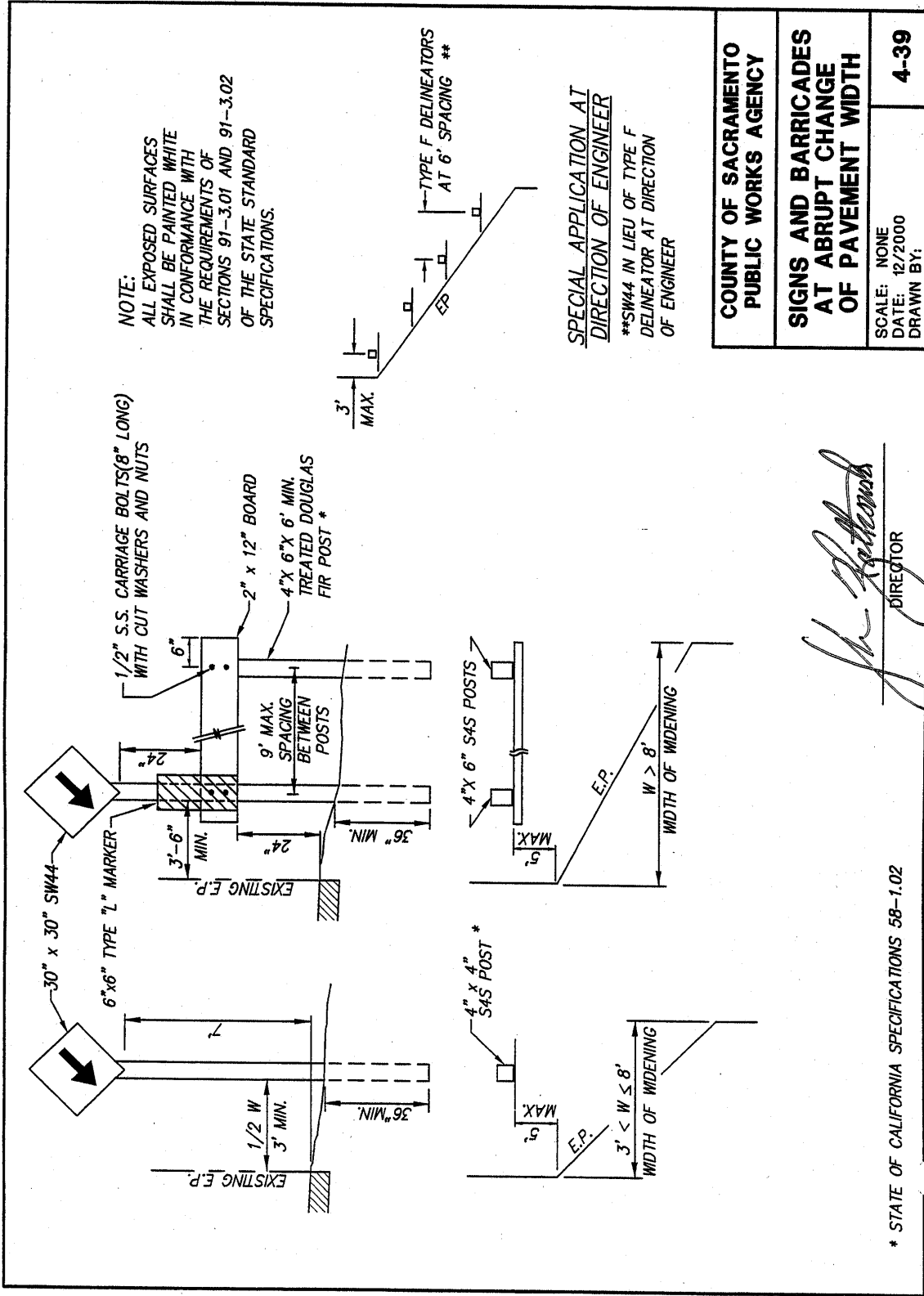

 DIRECTOR

COUNTY OF SACRAMENTO PUBLIC WORKS AGENCY	
STREET NAME SIGN INSTALLATION ON STREET LIGHT POLE	
SCALE: NONE DATE: 12/2000 DRAWN BY: COUNTY D.O.T.	4-36

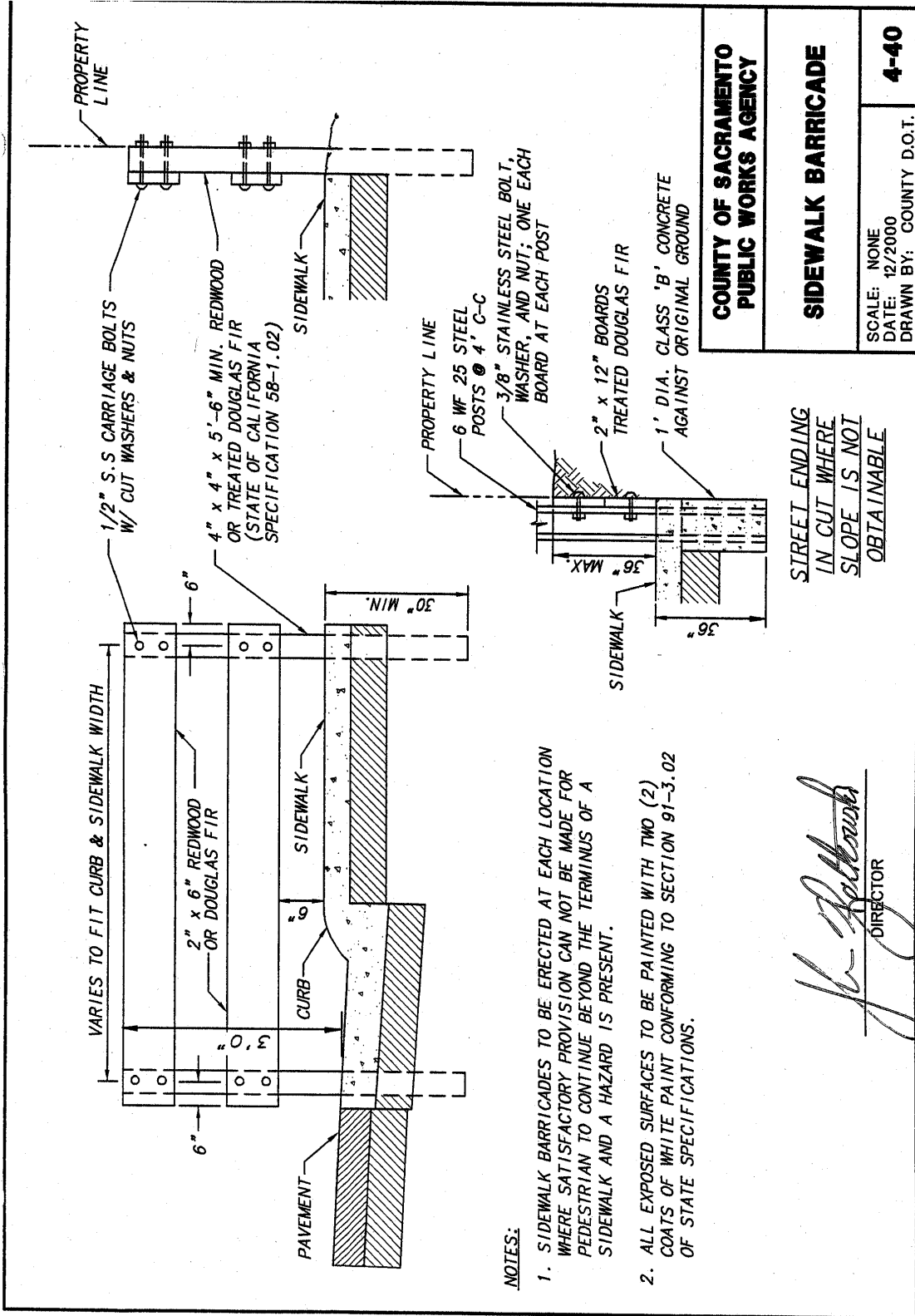

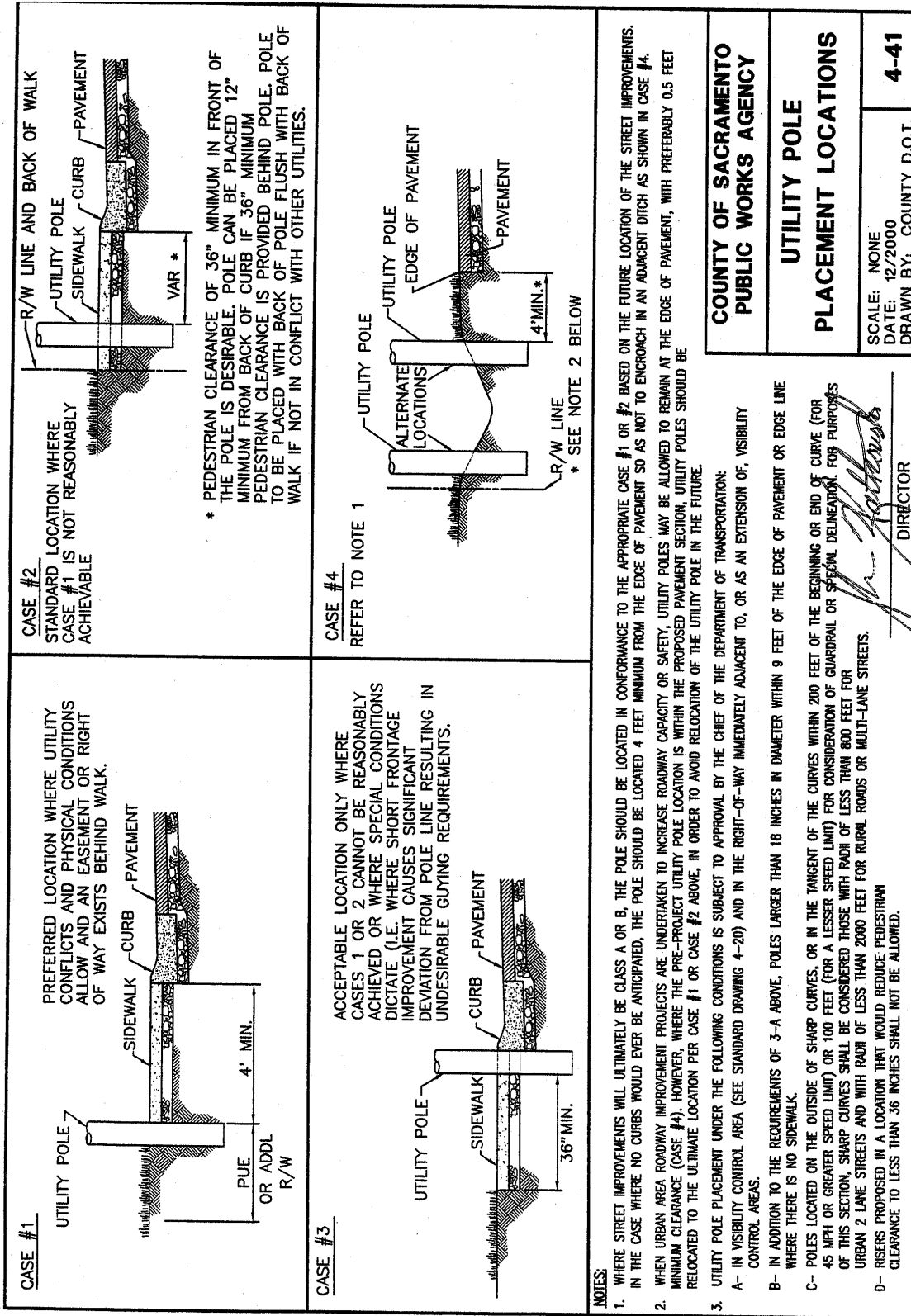



NOTES:

- WHERE STREET IMPROVEMENTS WILL ULTIMATELY BE CLASS A OR B, THE POLE SHOULD BE LOCATED IN CONFORMANCE TO THE APPROPRIATE CASE #1 OR #2 BASED ON THE FUTURE LOCATION OF THE STREET IMPROVEMENTS. IN THE CASE WHERE NO CURBS WOULD EVER BE ANTICIPATED, THE POLE SHOULD BE LOCATED 4 FEET MINIMUM FROM THE EDGE OF PAVEMENT SO AS NOT TO ENCRUSH IN AN ADJACENT DITCH AS SHOWN IN CASE #4.
- WHEN URBAN AREA ROADWAY IMPROVEMENT PROJECTS ARE UNDERTAKEN TO INCREASE ROADWAY CAPACITY OR SAFETY, UTILITY POLES MAY BE ALLOWED TO REMAIN AT THE EDGE OF PAVEMENT, WITH PREFERABLY 0.5 FEET MINIMUM CLEARANCE (CASE #4). HOWEVER, WHERE THE PRE-PROJECT UTILITY POLE LOCATION IS WITHIN THE PROPOSED PAVEMENT SECTION, UTILITY POLES SHOULD BE RELOCATED TO THE ULTIMATE LOCATION PER CASE #1 OR CASE #2 ABOVE, IN ORDER TO AVOID RELOCATION OF THE UTILITY POLE IN THE FUTURE.
- UTILITY POLE PLACEMENT UNDER THE FOLLOWING CONDITIONS IS SUBJECT TO APPROVAL BY THE CHIEF OF THE DEPARTMENT OF TRANSPORTATION:
 - A- IN VISIBILITY CONTROL AREA (SEE STANDARD DRAWING 4-20) AND IN THE RIGHT-OF-WAY IMMEDIATELY ADJACENT TO, OR AS AN EXTENSION OF, VISIBILITY CONTROL AREAS.
 - B- IN ADDITION TO THE REQUIREMENTS OF 3-A ABOVE, POLES LARGER THAN 18 INCHES IN DIAMETER WITHIN 9 FEET OF THE EDGE OF PAVEMENT OR EDGE LINE WHERE THERE IS NO SIDEWALK.
 - C- POLES LOCATED ON THE OUTSIDE OF SHARP CURVES, OR IN THE TANGENT OF THE CURVES WITHIN 200 FEET OF THE BEGINNING OR END OF CURVE (FOR 45 MPH OR GREATER SPEED LIMIT) OR 100 FEET (FOR A LESSER SPEED LIMIT) FOR CONSIDERATION OF GUARDRAIL OR SPECIAL DELINEATION FOR PURPOSES OF THIS SECTION, SHARP CURVES SHALL BE CONSIDERED THOSE WITH RADIUS OF LESS THAN 800 FEET FOR URBAN 2 LANE STREETS AND WITH RADIUS OF LESS THAN 2000 FEET FOR RURAL ROADS OR MULTI-LANE STREETS.
 - D- RISERS PROPOSED IN A LOCATION THAT WOULD REDUCE PEDESTRIAN CLEARANCE TO LESS THAN 36 INCHES SHALL NOT BE ALLOWED.

COUNTY OF SACRAMENTO PUBLIC WORKS AGENCY	
UTILITY POLE PLACEMENT LOCATIONS	
SCALE: NONE DATE: 12/2000	4-41
DRAWN BY: COUNTY D.O.T.	

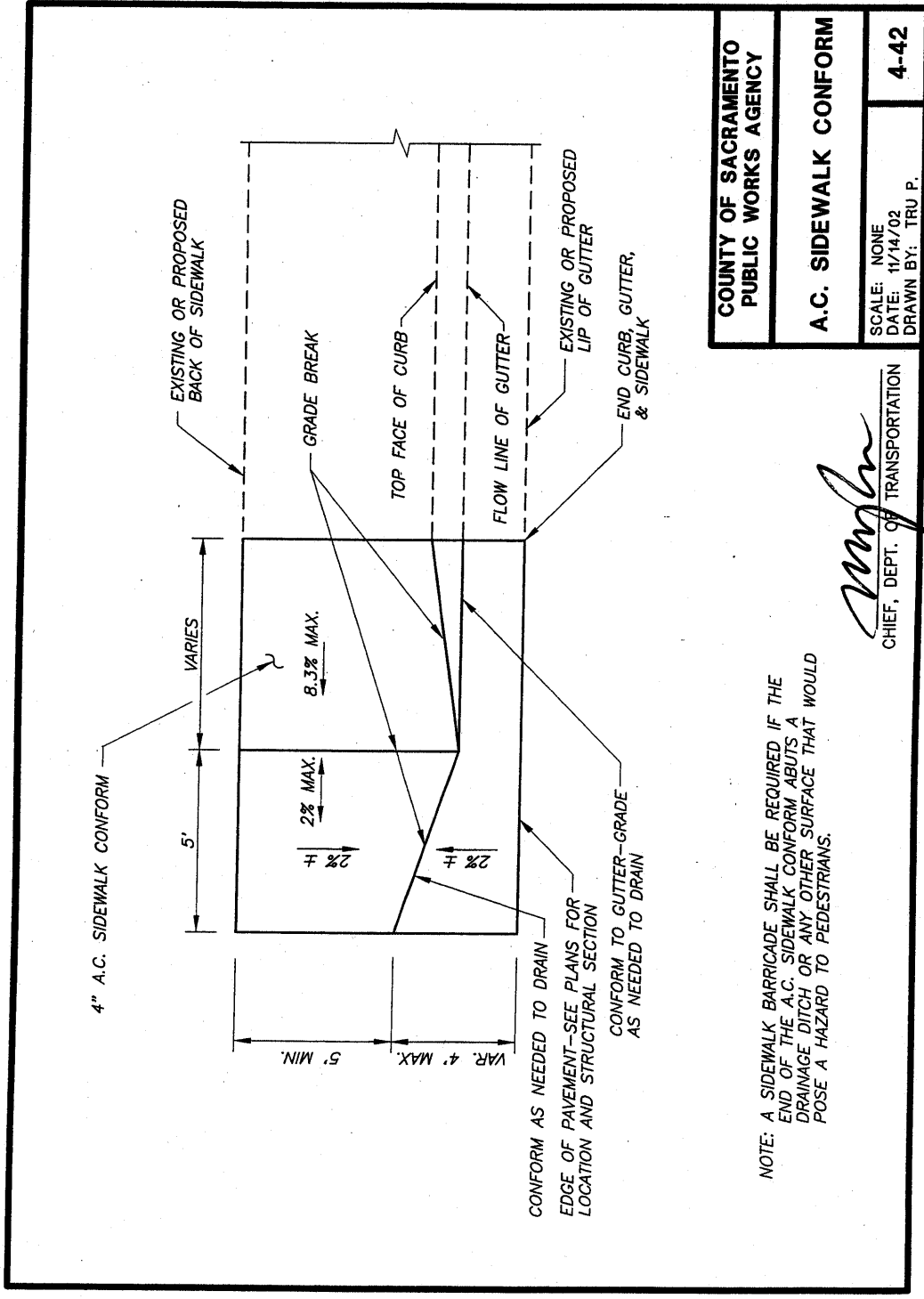

 DIRECTOR



COUNTY OF SACRAMENTO PUBLIC WORKS AGENCY	
A.C. SIDEWALK CONFORM	
SCALE: NONE	4-42
DATE: 11/14/02	
DRAWN BY: TRU P.	

NOTE: A SIDEWALK BARRICADE SHALL BE REQUIRED IF THE END OF THE A.C. SIDEWALK CONFORM ABUTS A DRAINAGE DITCH OR ANY OTHER SURFACE THAT WOULD POSE A HAZARD TO PEDESTRIANS.

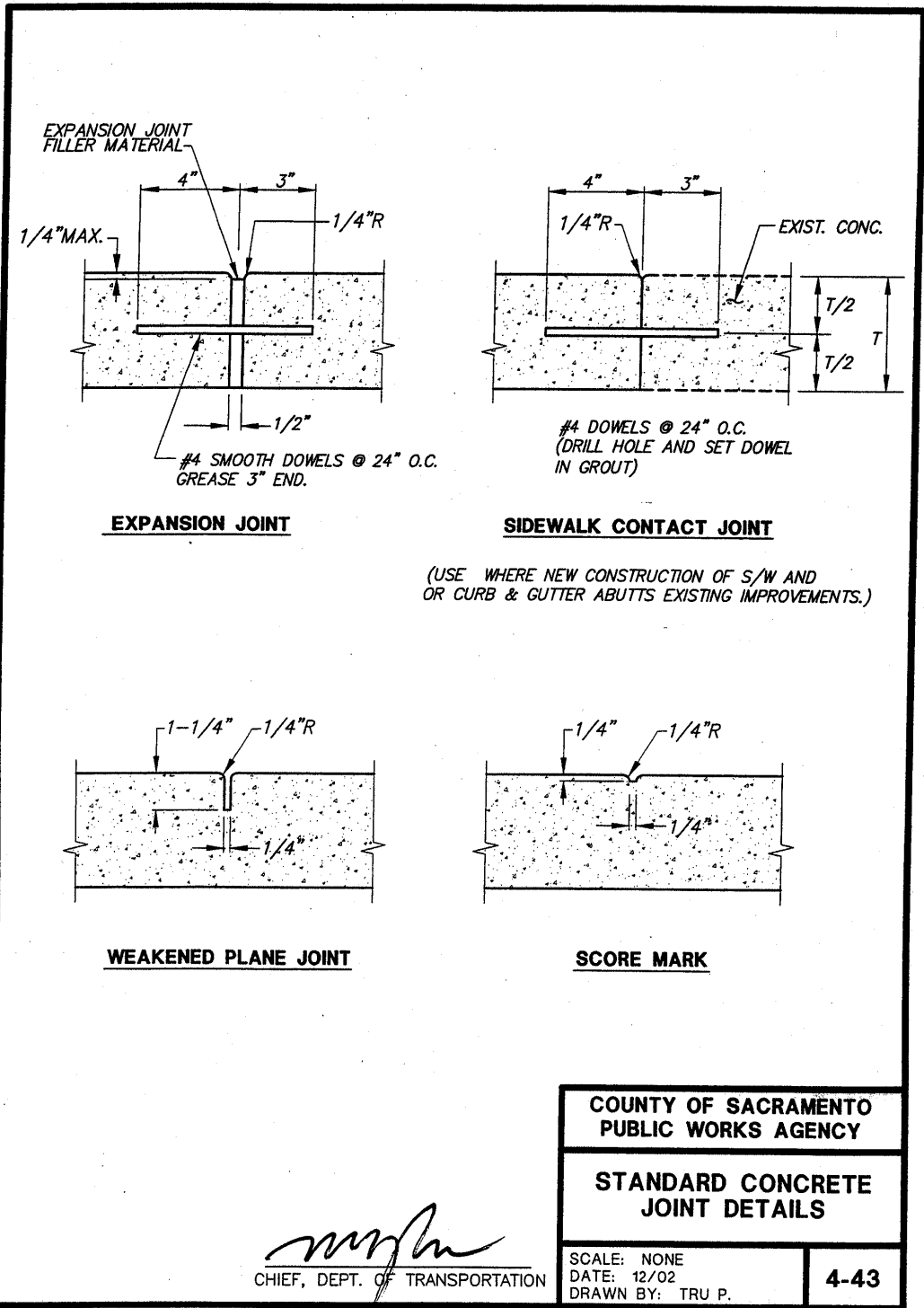
[Signature]
CHIEF, DEPT. OF TRANSPORTATION



Appendix C: Capital Implementation Program Project List

Legend for Project List

Use Priorities

- A. Public input requests
 - 1. Government services.
 - 2. Commercial, business or multi-family residential.
 - 3. Single-family residential.

(Refer to Section 6.3 for detailed descriptions)

Condition Priorities

- 1) Reconstruct curb ramps at locations where existing curb ramps have an unsafe condition that may cause a trip and fall.
- 2) A new curb ramp will be installed at locations where there is no curb ramp to provide accessibility.
- 3) When a corner has one existing curb ramp and conditions allow for the construction of an additional curb ramp at the same corner, and provided that traffic controls allow for a safe path of travel, an additional curb ramp will be installed.
- 4) A curb ramp is constructed or reconstructed at a location with difficult physical conditions such as major utility conflicts, physical barriers or other constraints, which would create a hardship situation on the entity.
- 5) An existing curb ramp will be reconstructed when it does not meet current federal and state accessibility standards

(Refer to Section 6.3 for detailed descriptions)

Work Scope Codes

- (1) Complete ADA retrofit of signalized four-way intersection.
- (2) Complete ADA retrofit of controlled intersection.
- (3) Complete ADA retrofit of signalized T-intersection.
- (4) At signalized intersections, installation of new accessible pedestrian signals with push buttons and crosswalk striping for all crossing directions where crosswalks are required by the ADA Codes and Standards.
- (5) Partial ADA retrofit at four-way intersection, single-family residential area.
- (6) Partial ADA retrofit at T-intersection, single-family residential area.
- (7) One or more new single curb ramps where other curb ramps at the intersection are complying.
- (8) Renovation of existing curb ramp to remove hazardous conditions.
- (9) Installation of new curb, gutter and concrete sidewalk.

- (10) Partial curb, gutter and sidewalk installation to provide programmatic access.
- (11) Miscellaneous sidewalk or walkway repair or replacement.
- (12) Selected sidewalk and bus pad pavement as required for transit access.
- (13) Selected sidewalk and bus pad pavement as required for new mid-block crosswalk with pedestrian signals.
- (14) Roadway widening or installation of required asphalt conforms for accessible pedestrian access routes.
- (15) Removal of sidewalk barriers.

(Refer to Section 6.2 for detailed descriptions)

Funding Codes

- A. Measure A sales tax funds.
- B. Disabled Access to Transit Program, funded by Congestion Mitigation and Air Quality Program (Federal TEA-21 Program).
- C. State Transportation Improvement Program (STIP) (includes Measure A sales tax funds and specified developer fees).
- D. Regional Surface Transportation Program (includes Measure A sales tax funds and specified developer fees).
- E. Unused.
- F. Unused.
- G. Folsom Blvd. Enhancement Project, funded by State Transportation Improvement Program.
- H. Unused.
- I. Unused.
- J. Roadway Development Fee Capital Improvement Plan (includes Measure A sales tax funds).
- K. Unused.
- L. Unused.
- M. Sacramento Area Flood Control Agency administered (from Measure A sales tax funds).
- N. Unused.
- O. Unused.
- P. Federal Safe Routes to School Program.
- Q. Unused.
- R. Funds from Developer fees.
- S. Sidewalk Continuity Project, from Measure A sales tax funds.
- T. Unused
- U. Unused
- V. Unused
- W. Unused
- X. (also called CR) Elderly and Disabled Access Program, improvements determined from resident requests.
- Y. Major Intersection Projects, from Measure A sales tax funds.
- Z. ADA Transition Plan Implementation Projects, from combination of Measure A sales tax funds, developer fees and other currently unspecified funds.

City of Rancho Cordova Draft ADA Transition Plan

Street 1 (typically NS Street)	Street 2 (typically EW Street)	Land Use	Use	Condi- tion	Work Scope	Fund- ing	Crb Rmp	Aud. sig- nals	FY	Curb Ramp Costs	Signal Costs	Cross- walk Costs	Sidewalk Costs	Total Costs	
FY 2005-2006															
Zinfandel Dr	Olson Dr	Public Use	1	2	2	CR	8	No	05	\$50,080		\$6,080	\$6,560	\$62,720	
Van Nuys Way	Ambassador Dr	School	1	2	4	Z	4	No	05	\$25,040		\$3,040	\$6,150	\$34,230	
VEHICLE DR	COLOMA RD	Public Use	1	1	10	Z	1	No	05	\$145				\$145	
COLOMA RD	KIMWOOD LN	Public Use	1	1	10	Z	2	No	05	\$290				\$290	
TRINITY RIVER DR	SUNRISE BLVD	Public Use	1	1	10	Z	1	No	05	\$145				\$145	
TRADE CENTER DR	QUARRY CT	Public Use	1	1	10	Z	2	No	05	\$290				\$290	
OLSON DR	GWENDOLYN WAY	Commercial	2	1	10	Z	1	No	05	\$145				\$145	
GOLD CENTER DR	ZINFANDEL DR	Public Use	1	1	10	Z	1	No	05	\$145				\$145	
DATA DR	WHITE ROCK RD	Public Use	1	1	10	Z	2	No	05	\$290				\$290	
GREEN WING WAY	RAVEN'S WAY	Commercial	2	1	10	Z	1	No	05	\$145				\$145	
FOLSOM BLVD	PASEO RIO WAY	Public Use	1	1	10	Z	1	No	05	\$145				\$145	
SCHRIEVER AVE	OLD PLACERVILLE RD	Public Use	1	1	10	Z	1	No	05	\$145				\$145	
ROCKINGHAM DR	OLD PLACERVILLE RD	Public Use	1	1	10	Z	1	No	05	\$145				\$145	
KILGORE RD	WHITE ROCK RD	Public Use	1	1	10	Z	3	No	05	\$435				\$435	
WHITE ROCK RD	PROSPECT PARK DR	Public Use	1	1	10	Z	2	No	05	\$290				\$290	
ZINFANDEL DR	HWY 50	Public Use	1	1	10	Z	1	No	05	\$145				\$145	
SUNRISE BLVD	WHITE ROCK RD	Public Use	1	1	10	Z	1	No	05	\$145				\$145	
			17								\$78,165	\$0	\$9,120	\$12,710	\$99,995
FY 2006-2007															
Rossmoor Dr	Ambassador Dr	School	1	2	2	Z	4	No	07	\$25,040		\$6,080	\$6,150	\$37,270	
Ambassador Dr	Forestlake Dr	School	1	2	2	Z	6	No	07	\$37,560		\$4,560	\$6,150	\$48,270	
			2								\$62,600	\$0	\$10,640	\$12,300	\$85,540
FY 2007-2008															
Mather Field Rd	Folsom Blvd	Transit & School	1	2	1	G	8	Yes	06	\$50,080	\$11,840	\$6,080	\$9,840	\$77,840	
Rod Beaudry Dr	Folsom Blvd	Commercial	1	2	9	G	2	No	06	\$12,520		\$1,520	\$1,750	\$15,790	
Coloma Rd	Folsom Blvd	Commercial	1	2	3	G	6	Yes	06	\$37,560	\$8,880	\$4,560	\$1,750	\$52,750	
Zinfandel Dr	Folsom Blvd	Transit & School	1	2	1	G	8	Yes	06	\$50,080	\$11,840	\$6,080	\$9,840	\$77,840	
Cordova Ln	Folsom Blvd	Commercial	2	2	1	G	8	Yes	06	\$50,080	\$11,840	\$3,040	\$1,750	\$66,710	
Routier Rd	Folsom Blvd	Transit & School	1	2	3	G	6	Yes	06	\$37,560	\$8,880	\$4,560	\$9,840	\$60,840	
Bravado Dr	Folsom Blvd	Commercial	1	2	9	G	2	No	06	\$12,520		\$1,520	\$1,750	\$15,790	
La Loma Dr	Folsom Blvd	Commercial	1	2	9	G	2	No	06	\$12,520		\$1,520	\$1,750	\$15,790	
White Rock Rd	Folsom Blvd	Commercial	1	2	9	G	2	No	06	\$12,520		\$1,520	\$1,750	\$15,790	
Investment Cir W	Folsom Blvd	Commercial	2	2	9	G	2	No	06	\$12,520		\$760	\$1,750	\$15,030	
Investment Cir E	Folsom Blvd	Commercial	2	2	9	G	2	No	06	\$12,520		\$760	\$1,750	\$15,030	

City of Rancho Cordova Draft ADA Transition Plan

Street 1 (typically NS Street)	Street 2 (typically EW Street)	Land Use	Use	Condi- tion	Work Scope	Fund- ing	Crb Rmp	Aud. sig- nals	FY	Curb Ramp Costs	Signal Costs	Cross- walk Costs	Sidewalk Costs	Total Costs	
Aramon Dr	Folsom Blvd	Commercial	2	2	9	G	2	No	06	\$12,520		\$760	\$1,750	\$15,030	
Don Juan Dr	Folsom Blvd	Commercial	2	2	9	G	2	No	06	\$12,520		\$760	\$1,750	\$15,030	
McGregor Dr	Folsom Blvd	Commercial	2	2	9	G	2	No	06	\$12,520		\$760	\$1,750	\$15,030	
Sunrise Blvd	Folsom Blvd	Transit	1	2	1	G	8	Yes	06	\$50,080	\$11,840	\$6,080	\$8,200	\$76,200	
Dawes St	Folsom Blvd	Commercial	1	2	1	G	8	Yes	06	\$50,080	\$11,840	\$6,080	\$1,750	\$69,750	
Los Nogales Way	Folsom Blvd	Commercial	2	2	9	G	2	No	06	\$12,520		\$760	\$1,750	\$15,030	
Mills Park Dr	Folsom Blvd	Commercial	2	2	1	G	8	Yes	06	\$50,080	\$11,840	\$3,040	\$1,750	\$66,710	
Kilgore Rd	Folsom Blvd	Commercial	2	2	9	G	2	No	06	\$12,520		\$760	\$1,750	\$15,030	
			19								\$513,320	\$88,800	\$50,920	\$63,970	\$717,010
FY 2008-2009															
Cranor Dr	Ambassador Dr	School	1	2	4	Z	4	No	08	\$25,040		\$3,040	\$6,150	\$34,230	
Ambassador Dr	Lewitt Dr	School	1	2	4	Z	4	No	08	\$25,040		\$3,040	\$6,150	\$34,230	
Ambassador Dr	Elmanto Dr	Commercial	1	2	2	Z	4	No	08	\$25,040		\$6,080	\$1,750	\$32,870	
			3								\$75,120	\$0	\$12,160	\$14,050	\$101,330
FY 2009-2010															
Ambassador Dr	McGregor Dr	School	1	2	2	Z	6	No	09	\$37,560		\$4,560	\$6,150	\$48,270	
Mather Field Rd	Croydon Way	Transit & Public Use	1	2	4	Z	4	No	09	\$25,040		\$3,040	\$12,300	\$40,380	
			2								\$62,600	\$0	\$7,600	\$18,450	\$88,650
FY 2010-2011															
Blackpool Way	White Rock Rd	School	1	2	2	Z	6	No	10	\$37,560		\$4,560	\$6,150	\$48,270	
Mills Park Dr	Woodberry Way	Public Use	1	2	4	Z	4	No	10	\$25,040		\$3,040	\$6,560	\$34,640	
			2								\$62,600	\$0	\$7,600	\$12,710	\$82,910
FY 2011-2012															
Bradshaw Rd	Folsom Blvd	Transit & Public Use	1	2	1	CR	8	Yes	11	\$50,080	\$11,840	\$6,080	\$12,300	\$80,300	
			1								\$50,080	\$11,840	\$6,080	\$12,300	\$80,300
FY 2012-2013															
Mills Station Rd	Dain Ct	Public Use	1	2	4	Z	4	No	12	\$25,040		\$3,040	\$6,560	\$34,640	
Portsmouth Dr	Mills Station Rd	Public Use	1	2	4	Z	4	No	12	\$25,040		\$3,040	\$6,560	\$34,640	
Portsmouth Dr	Birmingham Way	Public Use	1	2	4	Z	4	No	12	\$25,040		\$3,040	\$6,560	\$34,640	
			3								\$75,120	\$0	\$9,120	\$19,680	\$103,920

City of Rancho Cordova Draft ADA Transition Plan

Street 1 (typically NS Street)	Street 2 (typically EW Street)	Land Use	Use	Condi- tion	Work Scope	Fund- ing	Crb Rmp	Aud. sig- nals	FY	Curb Ramp Costs	Signal Costs	Cross- walk Costs	Sidewalk Costs	Total Costs	
FY 2013-2014															
Winchester Way	Portsmouth Dr	Public Use	1	2	4	Z	4	No	13	\$25,040		\$3,040	\$6,560	\$34,640	
Ramsgate Way	Portsmouth Dr	Public Use	1	2	4	Z	4	No	13	\$25,040		\$3,040	\$6,560	\$34,640	
Dawes St	El Cedro Ct	Public Use	1	2	4	Z	4	No	13	\$25,040		\$3,040	\$6,560	\$34,640	
			3								\$75,120	\$0	\$9,120	\$19,680	\$103,920
FY 2014-2015															
Portsmouth Dr	Swansea Way	Commercial	1	2	2	Z	6	No	14	\$37,560		\$4,560	\$1,750	\$43,870	
Aramon Dr	Ribier Way	Public Use	1	2	2	Z	6	No	14	\$37,560		\$4,560	\$6,560	\$48,680	
			2								\$75,120	\$0	\$9,120	\$8,310	\$92,550
FY 2015-2016															
Mills Park Dr	Croetto Way	Public Use	1	2	2	Z	6	No	15	\$37,560		\$4,560	\$6,560	\$48,680	
Dawes St	Los Palos Dr	Commercial	1	2	2	Z	6	No	15	\$37,560		\$4,560	\$1,750	\$43,870	
			2								\$75,120	\$0	\$9,120	\$8,310	\$92,550
FY 2016-2017															
Dawes St	Dolecetto Dr	Public Use	1	2	4	Z	4	No	16	\$25,040		\$3,040	\$6,560	\$34,640	
Brenda Way	Dawes St	Public Use	1	2	4	Z	4	No	16	\$25,040		\$3,040	\$6,560	\$34,640	
Don Juan Dr	Le Ann Dr	School	1	2	4	Z	4	No	16	\$25,040		\$3,040	\$6,150	\$34,230	
			3								\$75,120	\$0	\$9,120	\$19,270	\$103,510
FY 2017-2018															
Barbera Way	Chassella Way	School	1	2	2	Z	6	No	17	\$37,560		\$4,560	\$6,150	\$48,270	
Rinda Dr	Chase Dr	School	1	2	2	Z	6	No	17	\$37,560		\$4,560	\$6,150	\$48,270	
			2								\$75,120	\$0	\$9,120	\$12,300	\$96,540
FY 2018-2019															
Tronero Way	Malaga Way	Transit	1	2	4	Z	4	No	18	\$25,040		\$3,040	\$8,200	\$36,280	
Chase Dr	Brenda Way	School	1	2	4	Z	4	No	18	\$25,040		\$3,040	\$6,150	\$34,230	
Doyle Way	Chase Dr	School	1	2	4	Z	4	No	18	\$25,040		\$3,040	\$6,150	\$34,230	
			3								\$75,120	\$0	\$9,120	\$20,500	\$104,740
FY 2019-2020															
Rinda Dr	Moraine Cir	Public Use	1	2	2	Z	6	No	19	\$37,560		\$4,560	\$6,560	\$48,680	
Furmint Way	Malaga Way	Commercial	1	2	2	Z	6	No	19	\$37,560		\$4,560	\$1,750	\$43,870	
			2								\$75,120	\$0	\$9,120	\$8,310	\$92,550

City of Rancho Cordova Draft ADA Transition Plan

Street 1 (typically NS Street)	Street 2 (typically EW Street)	Land Use	Use	Condi- tion	Work Scope	Fund- ing	Crb Rmp	Aud. sig- nals	FY	Curb Ramp Costs	Signal Costs	Cross- walk Costs	Sidewalk Costs	Total Costs	
FY 2020-2021															
Zinfandel Dr	Chassella Way	Public Use	1	2	4	Z	4	No	20	\$25,040		\$3,040	\$6,560	\$34,640	
Daniel Way	Chase Dr	School	1	2	4	Z	4	No	20	\$25,040		\$3,040	\$6,150	\$34,230	
Zinfandel Dr	Alicante Way	Public Use	1	2	4	Z	4	No	20	\$25,040		\$3,040	\$6,560	\$34,640	
			3								\$75,120	\$0	\$9,120	\$19,270	\$103,510
FY 2021-2022															
Holmes Way	Chase Dr	Public Use	1	2	4	Z	4	No	21	\$25,040		\$3,040	\$6,560	\$34,640	
Ribier Wy	Malaga Way	Public Use	1	2	2	Z	8	No	21	\$50,080		\$6,080	\$6,560	\$62,720	
			2								\$75,120	\$0	\$9,120	\$13,120	\$97,360
FY 2022-2023															
Dawes St	Doyle Way	Public Use	1	2	4	Z	4	No	22	\$25,040		\$3,040	\$6,560	\$34,640	
Augibi Way	Malaga Way	Public Use	1	2	4	Z	4	No	22	\$25,040		\$3,040	\$6,560	\$34,640	
Mills Park Dr	Olson Dr	Public Use	1	2	4	Z	4	No	22	\$25,040		\$3,040	\$6,150	\$34,230	
			3								\$75,120	\$0	\$9,120	\$19,270	\$103,510
FY 2023-2024															
Moraine Cir	Thores St	Public Use	1	2	4	Z	4	No	23	\$25,040		\$3,040	\$6,560	\$34,640	
Mills Park Dr	Mills Tower Dr	School	1	2	4	Z	4	No	23	\$25,040		\$3,040	\$6,150	\$34,230	
			2								\$50,080	\$0	\$6,080	\$12,710	\$68,870
FY 2024-2025															
Los Amigos Dr	Malaga Way	Transit	1	2	2	Z	6	No	24	\$37,560		\$4,560	\$8,200	\$50,320	
El Segundo Dr	Malaga Way	Transit	1	2	2	Z	6	No	24	\$37,560		\$4,560	\$8,200	\$50,320	
			2								\$75,120	\$0	\$9,120	\$16,400	\$100,640

City of Rancho Cordova Draft ADA Transition Plan

Beyond 20-Year Discretionary Funding Program - Projects for Competitive Funding

Street 1 (typically NS Street)	Street 2 (typically EW Street)	Land Use	Use	Condi- tion	Work Scope	Fund- ing	Crb Rmp	Aud. sig- nals*	FY	Curb Ramp Costs	Signal Costs	Cross- walk Costs	Sidewalk Costs	Total Costs
Trade Center Dr	Sun Center Dr	Transit & School	1	2	4	Z	4	No	25	\$25,040		\$3,040	\$9,840	\$37,920
Gilbert Way	Malaga Way	Transit	1	2	4	Z	4	No	25	\$25,040		\$3,040	\$8,200	\$36,280
Benny Way	Malaga Way	Transit	1	2	4	Z	4	No	25	\$25,040		\$3,040	\$8,200	\$36,280
Mills Park Dr	Glenview Way	School	1	2	4	Z	4	No	25	\$25,040		\$3,040	\$6,150	\$34,230
Paseo Dr	Malaga Way	Transit	1	2	2	Z	8	No	25	\$50,080		\$6,080	\$8,200	\$64,360
La Rue Way	Mills Tower Dr	Commercial	1	2	4	Z	4	No	25	\$25,040		\$3,040	\$1,750	\$29,830
Mills Park Dr	Marcel Way	School	1	2	4	Z	4	No	25	\$25,040		\$3,040	\$6,150	\$34,230
Buena Plaza Cir	Mills Tower Dr	Public Use	1	2	4	Z	4	No	25	\$25,040		\$3,040	\$6,560	\$34,640
Mills Acres Cir	White Rock Rd	School	1	2	4	Z	4	No	25	\$25,040		\$3,040	\$6,150	\$34,230
Mills Station Rd	White Rock Rd	School	1	2	4	Z	4	No	25	\$25,040		\$3,040	\$6,150	\$34,230
Joerger St	White Rock Rd	School	1	2	4	Z	4	No	25	\$25,040		\$3,040	\$6,150	\$34,230
Mills Tower Dr	White Rock Rd	School	1	2	2	Z	6	No	25	\$37,560		\$4,560	\$6,150	\$48,270
Portsmouth Dr	White Rock Rd	School	1	2	4	Z	4	No	25	\$25,040		\$3,040	\$6,150	\$34,230
Swansea Way	White Rock Rd	School	1	2	4	Z	4	No	25	\$25,040		\$3,040	\$6,150	\$34,230
Mather Field Rd	Mills Station Rd	Transit & Public Use	1	2	1	Z	8	Yes	25	\$50,080	\$11,840	\$6,080	\$12,300	\$80,300
Mather Field Rd	Rockingham Dr	Transit	1	2	1	Z	8	Yes	25	\$50,080	\$11,840	\$6,080	\$8,200	\$76,200
Femoyer St	Mather Blvd	Transit & Public Use	1	2	2	Z	8	No	25	\$50,080		\$6,080	\$12,300	\$68,460
Femoyer St	Norden St	Transit & Public Use	1	2	4	Z	4	No	25	\$25,040		\$3,040	\$12,300	\$40,380
Bleckely St	Macready St	Transit & Public Use	1	2	2	Z	8	No	25	\$50,080		\$6,080	\$12,300	\$68,460
Forestlake Dr	Woodlawn Dr	School	1	2	2	Z	6	No	25	\$37,560		\$4,560	\$6,150	\$48,270
Maryvale Way	Ambassador Dr	School	1	2	4	Z	4	No	25	\$25,040		\$3,040	\$6,150	\$34,230
Van Stralen Way	Forestlake Dr	School	1	2	2	Z	6	No	25	\$37,560		\$4,560	\$6,150	\$48,270
Carlos Way	Benita Dr	School	1	2	4	Z	4	No	25	\$25,040		\$3,040	\$6,150	\$34,230
Lucia Ct	Benita Dr	School	1	2	4	Z	4	No	25	\$25,040		\$3,040	\$6,150	\$34,230
Segovia Way	Benita Dr	School	1	2	2	Z	8	No	25	\$50,080		\$6,080	\$6,150	\$62,310
Forestlake Dr	Mcgregor Dr	School	1	2	4	Z	4	No	25	\$25,040		\$3,040	\$6,150	\$34,230
Pinturo Way	Benita Dr	School	1	2	4	Z	4	No	25	\$25,040		\$3,040	\$6,150	\$34,230
Sonata Dr	Benita Dr	School	1	2	4	Z	4	No	25	\$25,040		\$3,040	\$6,150	\$34,230
Benita Dr	Mapola Way	School	1	2	4	Z	4	No	25	\$25,040		\$3,040	\$6,150	\$34,230
Zinfandel Dr	Hirschfeld Way	Transit & School	1	2	4	Z	4	No	25	\$25,040		\$3,040	\$9,840	\$37,920
Coloma Rd	Gaywood Dr	Transit	1	2	4	Z	4	No	25	\$25,040		\$3,040	\$8,200	\$36,280
Carlos Way	McGregor Dr	Public Use	1	2	4	Z	4	No	25	\$25,040		\$3,040	\$6,560	\$34,640
McGregor Dr	Campana Way	Commercial	1	2	2	Z	8	No	25	\$50,080		\$6,080	\$1,750	\$57,910

City of Rancho Cordova Draft ADA Transition Plan

Street 1 (typically NS Street)	Street 2 (typically EW Street)	Land Use	Use	Condi- tion	Work Scope	Fund- ing	Crb Rmp	Aud. sig- nals*	FY	Curb Ramp Costs	Signal Costs	Cross- walk Costs	Sidewalk Costs	Total Costs
Coloma Rd	Rossmoor Dr	Transit	1	2	4	Z	4	No	25	\$25,040		\$3,040	\$8,200	\$36,280
Benita Dr	Zinfandel Dr	Transit & School	1	2	2	Z	6	No	25	\$37,560		\$4,560	\$9,840	\$51,960
Ellison Dr	Georgetown Dr	Commercial	1	2	4	Z	4	No	25	\$25,040		\$3,040	\$1,750	\$29,830
Sonata Dr	Zinfandel Dr	Transit & School	1	2	4	Z	4	No	25	\$25,040		\$3,040	\$9,840	\$37,920
Rose Hill Ct	Georgetown Dr	School	1	2	4	Z	4	No	25	\$25,040		\$3,040	\$6,150	\$34,230
Rugby Ct	Georgetown Dr	School	1	2	4	Z	4	No	25	\$25,040		\$3,040	\$6,150	\$34,230
Warrenton Dr	Georgetown Dr	School	1	2	4	Z	4	No	25	\$25,040		\$3,040	\$6,150	\$34,230
Zinfandel Dr	Queenwood Dr	Transit & School	1	2	4	Z	4	No	25	\$25,040		\$3,040	\$9,840	\$37,920
Ambassador Dr	River Vista Way	Commercial	1	2	4	Z	4	No	25	\$25,040		\$3,040	\$1,750	\$29,830
Georgetown Dr	Starrlyn Way	School	1	2	2	Z	6	No	25	\$37,560		\$4,560	\$6,150	\$48,270
McGregor Dr	Zinfandel Dr	Transit & School	1	2	2	Z	8	No	25	\$50,080		\$6,080	\$9,840	\$66,000
Queenwood Dr	Gadsten Way	Transit & School	1	2	4	Z	4	No	25	\$25,040		\$3,040	\$9,840	\$37,920
Ambassador Dr	River Edge Way	Public Use	1	2	2	Z	6	No	25	\$37,560		\$4,560	\$6,560	\$48,680
River Wood Way	River Edge Way	Commercial	1	2	4	Z	4	No	25	\$25,040		\$3,040	\$1,750	\$29,830
Georgetown Dr	Woodcliff Way	Public Use	1	2	4	Z	4	No	25	\$25,040		\$3,040	\$6,560	\$34,640
Cordova Ln	Zinfandel Dr	Transit & School	1	2	2	Z	6	No	25	\$37,560		\$4,560	\$9,840	\$51,960
Georgetown Dr	River Edge Way	School	1	2	2	Z	6	No	25	\$37,560		\$4,560	\$6,150	\$48,270
Queenwood Dr	Glenhaven Way	Transit	1	2	4	Z	4	No	25	\$25,040		\$3,040	\$8,200	\$36,280
Zinfandel Dr	Glenfaire Dr	School	1	2	4	Z	4	No	25	\$25,040		\$3,040	\$6,150	\$34,230
Aramon Dr	Semillon Way	Public Use	1	2	2	Z	6	No	25	\$37,560		\$4,560	\$6,560	\$48,680
Cordova Ln	Dunbar Way	Transit & School	1	2	4	Z	4	No	25	\$25,040		\$3,040	\$9,840	\$37,920
Georgetown Dr	Woodbridge Way	School	1	2	4	Z	4	No	25	\$25,040		\$3,040	\$6,150	\$34,230
Aramon Dr	Milazzo Way	Commercial	1	2	4	Z	4	No	25	\$25,040		\$3,040	\$1,750	\$29,830
Cordova Ln	Atwood Dr	Transit & School	1	2	2	Z	8	No	25	\$50,080		\$6,080	\$9,840	\$66,000
Georgetown Dr	Westwood Ct	School	1	2	4	Z	4	No	25	\$25,040		\$3,040	\$6,150	\$34,230
Cordova Ln	Ballantrae Way	Transit & School	1	2	4	Z	4	No	25	\$25,040		\$3,040	\$9,840	\$37,920
Italia Way	Zinfandel Dr	School	1	2	4	Z	4	No	25	\$25,040		\$3,040	\$6,150	\$34,230
Cordova Ln	Glenhaven Way	Transit & School	1	2	4	Z	4	No	25	\$25,040		\$3,040	\$9,840	\$37,920
Dolecetto Dr	Chardonay Dr	Commercial	1	2	4	Z	4	No	25	\$25,040		\$3,040	\$1,750	\$29,830
Cordova Ln	Alandale Way	Transit & School	1	2	4	Z	4	No	25	\$25,040		\$3,040	\$9,840	\$37,920
Coloma Rd	Dattier Ct	Transit & School	1	2	4	Z	4	No	25	\$25,040		\$3,040	\$9,840	\$37,920
Catawba Way	Chassella Way	School	1	2	4	Z	4	No	25	\$25,040		\$3,040	\$6,150	\$34,230
Don Juan Dr	Pedro Way	School	1	2	4	Z	4	No	25	\$25,040		\$3,040	\$6,150	\$34,230
Cordova Ln	Le Ann Dr	Transit & School	1	2	4	Z	4	No	25	\$25,040		\$3,040	\$9,840	\$37,920
Dolecetto Dr	Chassella Way	School	1	2	4	Z	4	No	25	\$25,040		\$3,040	\$6,150	\$34,230

City of Rancho Cordova Draft ADA Transition Plan

Street 1 (typically NS Street)	Street 2 (typically EW Street)	Land Use	Use	Condi- tion	Work Scope	Fund- ing	Crb Rmp	Aud. sig- nals*	FY	Curb Ramp Costs	Signal Costs	Cross- walk Costs	Sidewalk Costs	Total Costs	
Octavia Way	Chase Dr	Park	1	2	4	Z	4	No	25	\$25,040		\$3,040	\$16,400	\$44,480	
Pedro Way	Zinfandel Dr	School	1	2	2	Z	8	No	25	\$50,080		\$6,080	\$6,150	\$62,310	
Kilgore Rd	White Rock Rd	Transit	1	2	1	Z	8	Yes	25	\$50,080	\$11,840	\$6,080	\$8,200	\$76,200	
Evadna Dr	White Rock Rd	Public Use	1	2	2	Z	6	Yes	25	\$37,560	\$8,880	\$4,560	\$6,560	\$57,560	
TUSKET RIVER DR	TRINITY RIVER DR	Transit & Public Use	1	2	8	Z	1	No	25	\$5,760			\$12,300	\$18,060	
SABLE RIVER CT	TRINITY RIVER DR	Transit	1	2	8	Z	1	No	25	\$5,760			\$8,200	\$13,960	
OBERUN RIVER CT	TRINITY RIVER DR	Transit	1	2	8	Z	1	No	25	\$5,760			\$8,200	\$13,960	
TEXAS RIVER CT	TRINITY RIVER DR	Transit	1	2	8	Z	1	No	25	\$5,760			\$8,200	\$13,960	
TRINITY RIVER DR	KLAMATH RIVER DR	Transit	1	2	8	Z	1	No	25	\$5,760			\$8,200	\$13,960	
VEHICLE DR	COLOMA RD	Transit	1	2	8	Z	1	No	25	\$5,760			\$8,200	\$13,960	
COLOMA RD	TRUCKEE RIVER DR	Transit	1	1	8	Z	1	No	25	\$5,760			\$8,200	\$13,960	
GOLLER CT	HIRSCHFELD WAY	Commercial	2	1	8	Z	1	No	25	\$5,760			\$1,750	\$7,510	
HIRSCHFELD WAY	HIRSCHFELD WAY	Commercial	2	1	8	Z	1	No	25	\$5,760			\$1,750	\$7,510	
HIRSCHFELD WAY	BERRYWOOD DR	Commercial	2	1	8	Z	1	No	25	\$5,760			\$1,750	\$7,510	
QUEENWOOD DR	ALANDALE WAY	Public Use	1	1	8	Z	1	No	25	\$5,760			\$6,560	\$12,320	
MARCILEE WAY	SCOTSMAN WAY	Commercial	2	1	8	Z	1	No	25	\$5,760			\$1,750	\$7,510	
SUN CENTER DR	SUNRISE BLVD	Public Use	1	1	8	Z	1	No	25	\$5,760			\$6,560	\$12,320	
GOLD TAILINGS CT	SUN CENTER DR	Commercial	2	1	8	Z	1	No	25	\$5,760			\$1,750	\$7,510	
KILGORE RD	SUN CENTER DR	Commercial	2	1	8	Z	1	No	25	\$5,760			\$1,750	\$7,510	
SUN CENTER DR	PROSPECT PARK DR	Transit	1	1	8	Z	1	No	25	\$5,760			\$8,200	\$13,960	
OLSON DR	PLATINUM CT	Commercial	2	1	8	Z	1	No	25	\$5,760			\$1,750	\$7,510	
OLSON DR	GWENDOLYN WAY	Commercial	2	1	8	Z	1	No	25	\$5,760			\$1,750	\$7,510	
GOLD CAMP DR	COBBLEROCK DR	Public Use	1	1	8	Z	1	No	25	\$5,760			\$6,560	\$12,320	
GOLD CAMP DR	PROSPECT PARK DR	Transit	1	1	8	Z	1	No	25	\$5,760			\$8,200	\$13,960	
ZINFANDEL DR	HWY 50	Public Use	1	1	8	Z	1	No	25	\$5,760			\$6,560	\$12,320	
GOLD CENTER DR	PROSPECT PARK DR	Public Use	1	1	8	Z	1	No	25	\$5,760			\$6,560	\$12,320	
WHITE ROCK RD	GOLD VALLEY DR	Public Use	1	1	8	Z	1	No	25	\$5,760			\$6,560	\$12,320	
W LA LOMA DR	RIVER MIST WAY	School	1	2	8	Z	1	No	25	\$5,760			\$6,150	\$11,910	
ROD BEAUDRY DR	STIRLING PARK DR	Public Use	1	1	8	Z	1	No	25	\$5,760			\$6,560	\$12,320	
CROYDON WAY	MILLS STATION RD	Transit & Public Use	1	1	8	Z	1	No	25	\$5,760			\$12,300	\$18,060	
ROUTIER RD	HORN RD	Public Use	1	2	8	Z	1	No	25	\$5,760			\$6,560	\$12,320	
OLD WINERY PL	HORN RD	Commercial	2	2	8	Z	1	No	25	\$5,760			\$1,750	\$7,510	
OLD PLACERVILLE RD	SYSTEMS PKWY	Commercial	2	1	8	Z	1	No	25	\$5,760			\$1,750	\$7,510	
			101								\$2,370,560	\$44,400	\$267,520	\$687,390	\$3,369,870

